

STATE OF MINNESOTA

DISTRICT COURT

COUNTY OF HENNEPIN

FOURTH JUDICIAL DISTRICT

Case Type: Other Civil

State of Minnesota by its Attorney General, Keith Ellison,

Court File No. _____

Plaintiff,

COMPLAINT

vs.

Glock, Inc. and Glock Ges.m.b.H.,

Defendants.

1. Machine guns have been outlawed in Minnesota for nearly a century. But Glock has returned machine guns to Minnesota by making and selling semi-automatic handguns that are easily converted into illegal fully automatic weapons with “Glock switches”—small devices that allow Glock handguns to fire continuously with a single trigger pull.

2. Glock, Inc. and Glock Ges.m.b.H. encourage this conversion by promoting the “fun” of Glock 18 fully automatic machine guns, which are illegal for civilians to purchase.

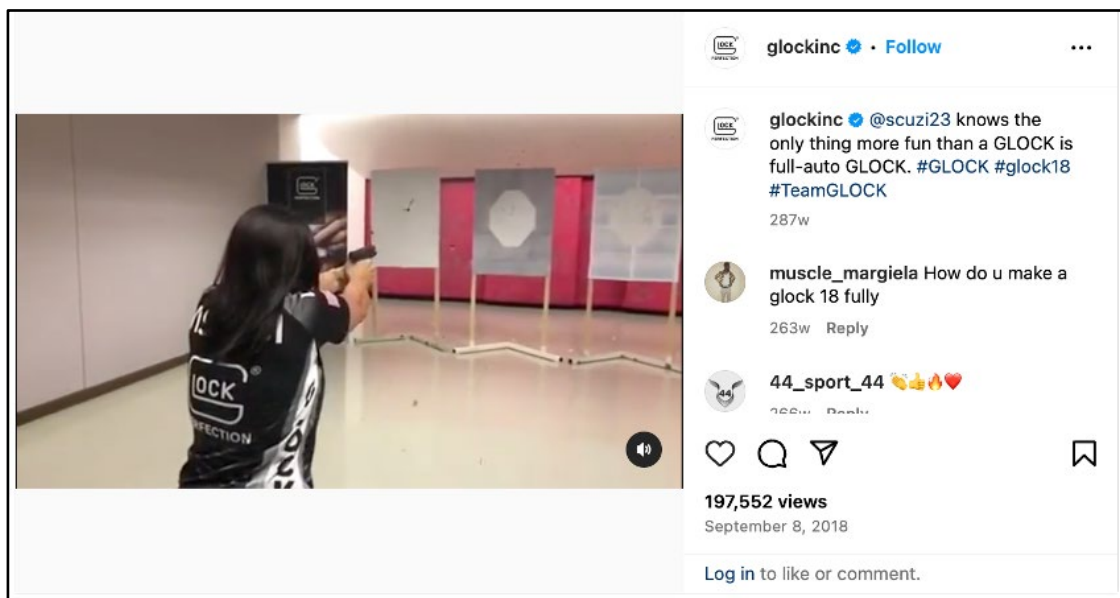

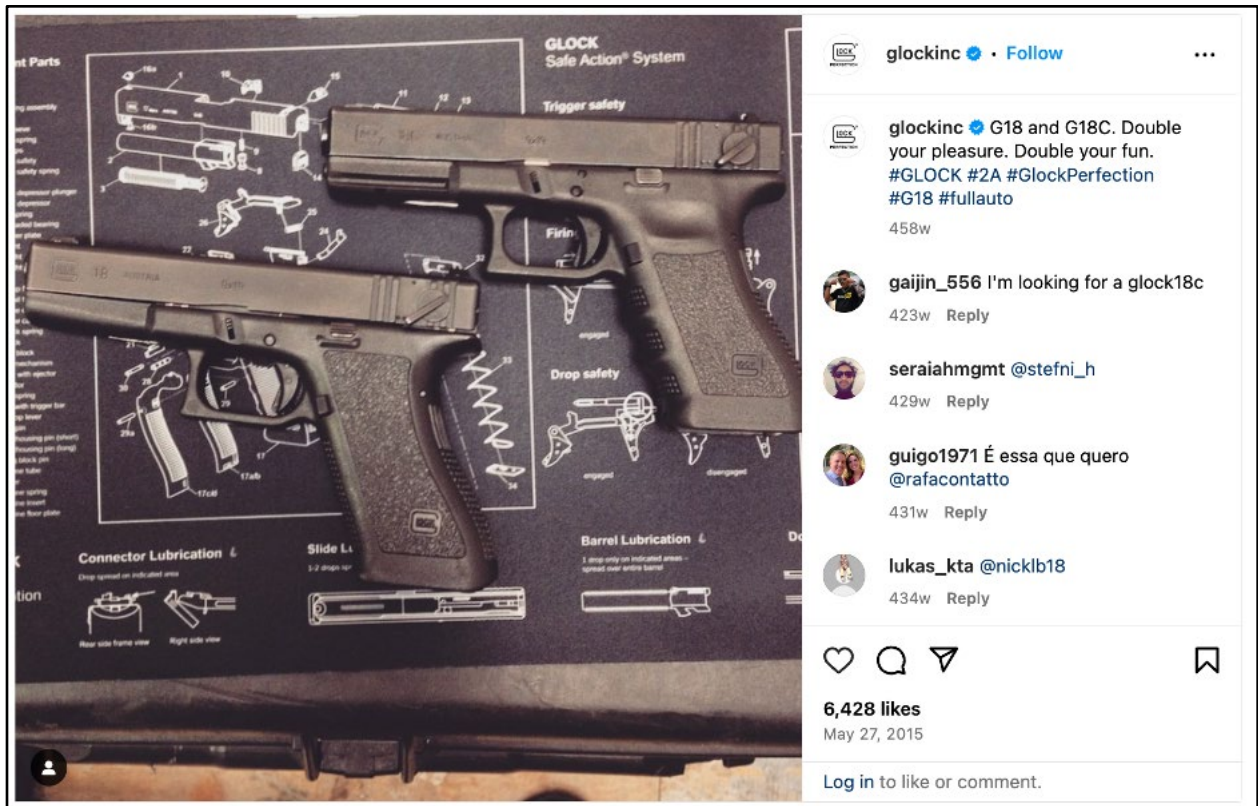

3. Glock knows that its semi-automatic handguns are being converted into illegal machine guns with Glock switches. Switches are illegal, and Glock does not make them, but many switches bear Glock's logo:



4. Glock could fix this problem by changing its handgun design to prevent the easy conversion of legal handguns into illegal machine guns. But Glock has chosen not to do so.

5. Given Glock's refusal to make design changes to deter conversion of its handguns, Glock handguns equipped with switches are killing and injuring Minnesotans like only machine

guns can. Converted Glock handguns are so difficult to aim and control that shooters “spray and pray,” with a high risk that bystanders may be shot.

6. On May 22, 2021, a Glock handgun equipped with a switch was used in a shootout on a crowded sidewalk outside a Minneapolis nightclub. Two shooters sprayed bullets at each other after a confrontation, and one shooter was killed. A bystander, a local college senior celebrating hours before his graduation ceremony, was also killed. He was hit in the back by a stray bullet as he fled from the gunfire and died at the scene. Seven additional victims were wounded with stray bullets.

7. On August 11, 2023, a Minneapolis police officer was shot by a .40 caliber Glock handgun equipped with a switch and an extended magazine. The officer approached the vehicle of a group of robbery suspects and was ambushed by a barrage of gunfire from the suspects. The suspects fired fifteen shots at the officer—twelve from the switch-equipped Glock handgun and only three shots from a semi-automatic handgun. One bullet pierced the officer’s right shoulder, narrowly missing a major artery before lodging in his chest.

8. The problem is growing. Across the United States, including in Minnesota, police are seeing an unprecedented increase in the number of semi-automatic Glock handguns converted into illegal fully automatic machine guns with Glock switches.

9. In 2023, the Minneapolis Police Department recovered three times as many Glock switches as they recovered in 2021, when the department first started tracking the devices.

10. Although machine guns remain outlawed under Minnesota law, machine gun fire in Minneapolis increased from 16 fully automatic gunfire incidents with 154 shots fired in 2020 to 257 incidents with 2,595 shots fired in 2023:

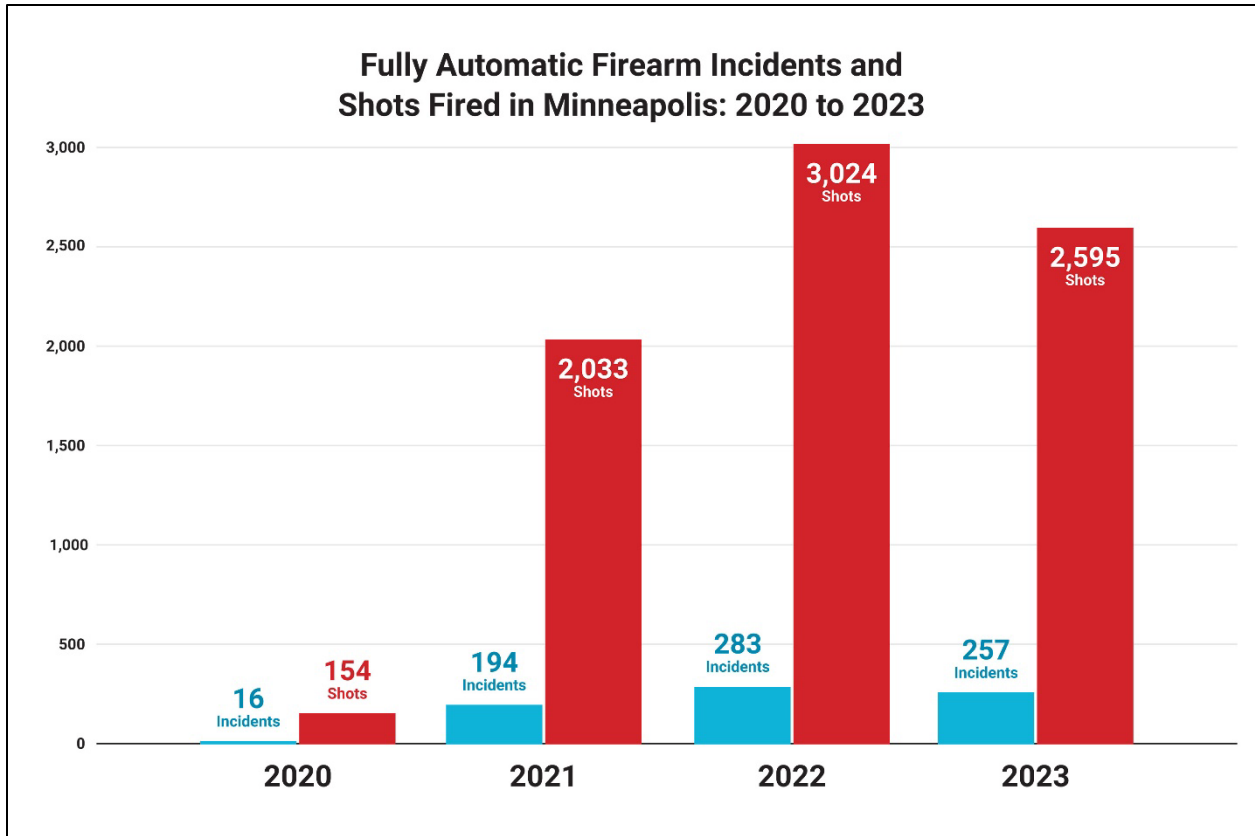

11. Minnesotans across the state now face the threat of fully automatic gunfire from Glock handguns converted into illegal machine guns.

12. Glock’s design, manufacture, and sale of semi-automatic handguns that are easily converted into illegal machine guns, coupled with Glock’s refusal to fix this known hazard, violates Minnesota law and must be stopped.

13. The Minnesota Attorney General brings this lawsuit on behalf of the people of the State of Minnesota to put an end to Glock’s illegal and harmful conduct and keep Minnesota communities safe from the scourge of illegal machine guns.

PARTIES

14. Keith Ellison, Attorney General of the State of Minnesota, is authorized under Minnesota Statutes chapter 8 and has common law authority, including *parens patriae* authority, to bring this action to enforce Minnesota’s laws, to vindicate the State’s sovereign and quasi-

sovereign interests, and to remediate all harm arising out of—and provide full relief for—violations of Minnesota’s laws.

15. Defendant Glock, Inc. is a firearm manufacturer and dealer with its principal place of business in Smyrna, Georgia. Glock, Inc. is incorporated under the laws of Georgia as a domestic for-profit corporation with its principal place of business at 6000 Highlands Parkway Southeast, Smyrna, Georgia, 30082. Glock, Inc. is registered as a foreign corporation authorized to do business in Minnesota and is directly involved in the design, manufacture, distribution, and marketing of Glock handguns sold in Minnesota.

16. Defendant Glock Ges.m.b.H. (“Glock Limited”) is an Austrian limited liability company with its principal place of business in Deutsch-Wagram, Austria. Glock Limited has stated that Glock, Inc. is the only company in the United States with which Glock Limited does business. Glock Limited and INC Holding GmbH, an Austrian holding company, jointly own Glock, Inc. Glock Limited participated with Glock, Inc. in the design, manufacturing, marketing, advertising, distribution, and sales of the handguns at issue in this case.

17. Glock Limited designs and manufactures handguns and component parts in Austria. Glock, Inc. then imports these handguns and component parts into the United States. Glock, Inc. uses Glock Limited’s component parts to assemble handguns that are distributed throughout the United States, including to residents of Minnesota. Glock, Inc. also distributes Glock Limited’s handguns throughout the United States, including to residents of Minnesota.

18. For many years, Glock Limited manufactured all Glock handguns that were sold in the United States. In 2013, Glock, Inc. began to manufacture handguns in the United States using

component parts supplied by Glock Limited from Austria. As of 2022, Glock Limited still manufactures the majority of Glock handguns sold in the United States.¹

19. Glock Limited controls the design and production standards used in Glock, Inc.’s manufacturing facilities in the United States. According to Glock Limited’s website, Glock, Inc.’s American facility “follows the same production standard and procedures as the facilities in Austria.”²

20. Glock handguns manufactured in Austria by Glock Limited and in the United States by Glock, Inc. have been distributed and sold in Minnesota.

21. Glock handguns, including those manufactured in Austria by Glock Limited, have been equipped with Glock switches in Minnesota.³

22. The Defendants are collectively referred to as “Glock” in this Complaint.

23. Glock distributes its handguns in Minnesota primarily through firearm dealers, who make them available for sale to civilians in Minnesota. Glock has relationships with and distributes its guns through its “GLOCK Stocking Dealer Program.”⁴ Stocking Dealers receive reduced pricing from Glock distributors, uniform advertising from Glock that can be used to market the products, and inclusion in the broader marketing program that Glock calls the “GLOCK marketing effort” (which includes a direct listing on Glock’s website and locator tool). Glock encourages

¹ Charlie Gao, *Made in America: Why Glock Manufacturing Is Set to Grow in the United States*, The National Interest (Aug. 6, 2021), <https://nationalinterest.org/blog/reboot/made-america-why-glock-manufacturing-set-grow-united-states-191274>.

² *Production sites*, Glock, <https://eu.glock.com/en/Explore-GLOCK/GLOCK-Company> (last visited Dec. 4, 2024).

³ Plea Agreement and Sentencing Stipulations, *United States v. Frazier*, No. 22-CR-126-NEB-TNL (D. Minn. Dec. 6, 2022) ECF No. 37 at 3 (defendant pled guilty to possession of a Glock 19 that was manufactured in Austria and that was equipped with a Glock switch).

⁴ *GLOCK Stocking Dealer Program*, Glock, <https://us.glock.com/dealers> (last visited Dec. 4, 2024).

dealers to join its Stocking Dealer Program, which promotes consistent branding and acts as the primary distribution method for Glock's products to reach civilians.

24. Through Glock's website, Minnesota residents can browse Glock's dealer locator tool to identify a Stocking Dealer⁵ and then click a direct link to the Stocking Dealer's website where they can purchase newly manufactured Glock handguns.

25. As of December 2024, Glock's website lists over 100 Stocking Dealers across Minnesota.

26. Glock also distributes its handguns in Minnesota through its "Blue Label Program." Glock's Blue Label Program is an "exclusive" program targeted at law enforcement customers that provides discount purchases of "two GLOCK pistols per calendar year."⁶ As of December 2024, Glock's website lists nearly twenty Minnesota dealers who participate in the Blue Label Program.

27. Glock makes hundreds of millions of dollars every year from firearm sales and is estimated to have a 65% market share of handgun sales in the United States.⁷

JURISDICTION AND VENUE

28. This Court has subject matter jurisdiction over this action pursuant to Minnesota Statutes section 8.01 and common law, including the State's *parens patriae* authority.

29. Defendants have deliberately done the following: solicited, approved, and/or partnered with Minnesota-based dealers in the sale of Glock handguns; worked together with

⁵ *GLOCK Dealer Locator*, Glock, <https://us.glock.com/en/Dealer-Locator-USA> (last visited Dec. 9, 2024).

⁶ *GLOCK Blue Label Program*, Glock, <https://us.glock.com/en/buy/blue-label-program> (last visited Dec. 9, 2024).

⁷ Deniz Cam, *The Billionaire Who Got Rich Off Glock Guns, Used By The Police As Well As Mass Shooters*, *Forbes* (Nov. 19, 2018), <https://www.forbes.com/sites/denizcam/2018/11/19/the-billionaire-who-got-rich-off-glock-pistols/#7731cbc04e50>.

dealers in and around Minnesota to sell Glock handguns to Minnesota civilians; marketed and advertised Glock handguns to Minnesota civilians; designed, manufactured, and sold Glock handguns calculated to be purchased by Minnesotans and/or possessed in Minnesota; worked in concert with one another to knowingly do all of the same; and, through their Minnesota business dealings, deliberately profited from the Minnesota civilian market for Glock handguns.

30. This Court has personal jurisdiction over Glock, Inc. because Glock, Inc. is registered to and does business in Minnesota. Glock, Inc. engages directly and through its agents in systematic and ongoing business transactions in Minnesota, including, but not limited to, the design, import, marketing, supply, warranty, distribution, misrepresentation, and sales of the products that form the basis of this suit. Glock, Inc. intended to, and does, target Minnesota residents for handgun sales, including by marketing and advertising Glock handguns to Minnesotans. Glock, Inc. works directly with Minnesota retailers, distributors, and other entities to market and sell its handguns in Minnesota, availing itself of the benefits of the laws of Minnesota.

31. This Court has personal jurisdiction over Glock Limited because it has sufficient minimum contacts with Minnesota, and Glock Limited has intentionally availed itself of the laws of Minnesota by conducting a substantial amount of business throughout the State, including, but not limited to, the distribution, sale, and warranty of Glock handguns in Minnesota. Glock Limited is responsible for the design and manufacture of Glock handguns that are imported into the United States and distributed throughout the country, including to Minnesota residents. Through its ownership of Glock, Inc. and sale of handguns to Glock, Inc. knowing that the handguns will then be sold and distributed into Minnesota, Glock Limited intended to, and does, target Minnesota residents for handgun sales, including by marketing and advertising Glock handguns to

Minnesotans. Through the misconduct alleged in this lawsuit, Glock Limited has committed torts against Minnesota residents and violated Minnesota laws.

32. Venue in Hennepin County is proper under Minnesota Statutes section 542.09 because the causes of action arose, in part, in Hennepin County. Glock has done business in Hennepin County, and Glock's unlawful acts have affected Hennepin County residents, among others.

ALLEGATIONS

I. Glock Designs, Manufactures, Markets, and Sells Semi-Automatic Handguns That Are Easily Converted into Illegal and Dangerous Fully Automatic Machine Guns with Glock Switches.

A. Machine Guns and Machine Gun Conversion Kits Are Illegal Under Minnesota Law.

33. For civilians, owning, possessing, or operating a machine gun is a crime under Minnesota law punishable by imprisonment for up to 20 years. Minn. Stat. § 609.67, subd. 2(a).

34. Minnesota law defines a "machine gun" as "any firearm designed to discharge, or capable of discharging automatically more than once by a single function of the trigger." Minn. Stat. § 609.67, subd. 1(a).

35. Minnesota law imposes the same penalty for possession of "any trigger activator or machine gun conversion kit." Minn. Stat. § 609.67, subd. 2(a).

36. Minnesota law defines a "machine gun conversion kit" as "any part or combination of parts designed and intended for use in converting a weapon into a machine gun, and any combination of parts from which a machine gun can be assembled." Minn. Stat. § 609.67, subd. 1(e).

37. Minnesota first outlawed machine guns in 1933, in a law providing that “[a]ny person who shall own, control, use, possess, sell or transport a machine gun, as herein defined, in violation of this Act, shall be guilty of a felony.” 1933 Minn. Laws, ch. 190 § 3.

B. Glock Switches Easily Convert Semi-Automatic Glock Handguns into Illegal and Dangerous Fully Automatic Machine Guns.

38. Semi-automatic guns require a separate trigger pull to fire each bullet. In contrast, fully automatic guns fire successive bullets continuously with a single trigger pull until the trigger is released or the supply of ammunition is exhausted. Fully automatic guns meet the legal definition of “machine gun” under Minnesota law.

39. Devices that convert semi-automatic guns into fully automatic machine guns are commonly known as “auto sears” because they interact with a part of the gun known as the “sear” to enable automatic gunfire.

40. A “Glock switch” is a type of auto sear designed for use with Glock semi-automatic handguns.

41. The Glock “switch” name originates from the fact that many Glock switches allow for switching or toggling between semi-automatic and fully automatic firing modes.

42. Glock switches are made out of metal or plastic and are roughly the size of a dime.⁸

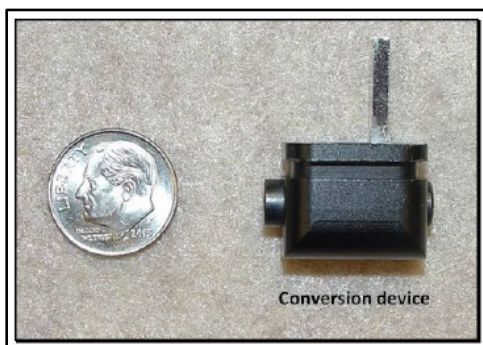

⁸ Bureau of Alcohol, Tobacco, Firearms and Explosives, ATF Firearms & Ammunition Technology Division Technical Bulletin 17-04 (2017), *United States v. Freitas*, No. 20-cr-223 (N.D. Cal. May 29, 2020), ECF No. 42, Ex. 5.



43. Attaching a Glock switch is straightforward, quick, and does not require technical knowledge or specialized tools. Like replacing the batteries in a remote control, a user simply removes the plastic slide cover plate from the back of a Glock handgun and attaches the Glock switch.

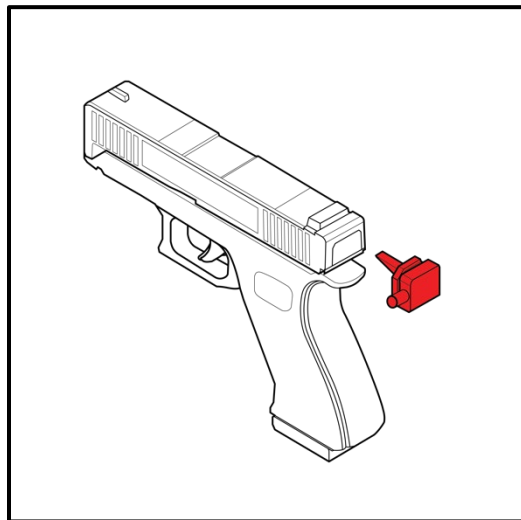

Figure A: Glock Handgun and Glock Switch.

44. A Glock switch works by limiting the function of a Glock handgun’s “trigger bar,” which is a large internal mechanism that effectively functions as the “sear” in Glock handguns.

When a Glock switch is not attached, a Glock handgun's trigger bar ensures the gun only fires one bullet per trigger pull by stopping the "striker" or "firing pin"—the part of the gun that "strikes" the round to fire the bullet—after one shot is fired.

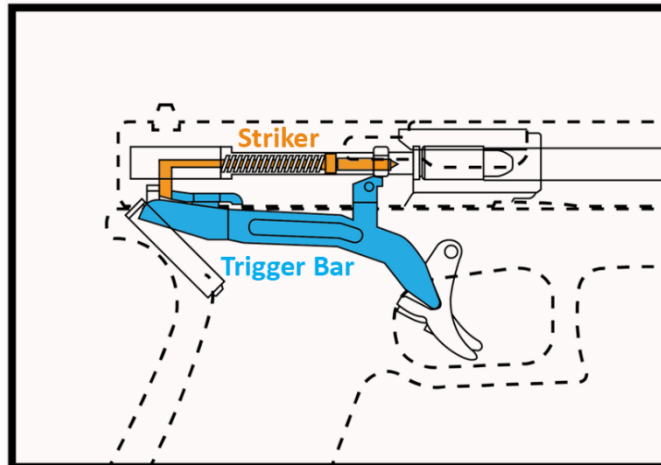

Figure B: A semi-automatic Glock handgun without a Glock switch attached, showing the trigger bar stopping the striker from moving forward.

45. When a Glock switch is attached, however, the switch inserts an angled metal or plastic "disconnect" bar into the back of the gun, thereby "disconnecting" the trigger bar from the striker and preventing the trigger bar from stopping the striker after each shot. As a result, when a Glock handgun is equipped with a switch, the unimpeded striker will continue firing bullets with one trigger pull until the trigger is released or the supply of ammunition is exhausted.

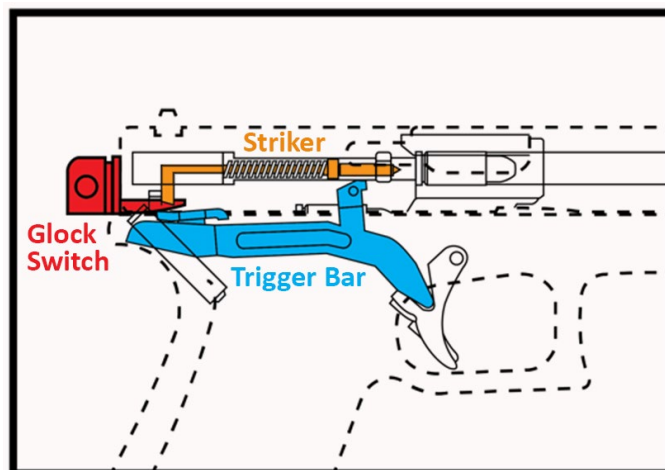

Figure C: A Glock handgun with a Glock switch attached, showing how the Glock switch holds down the trigger bar to enable automatic firing.

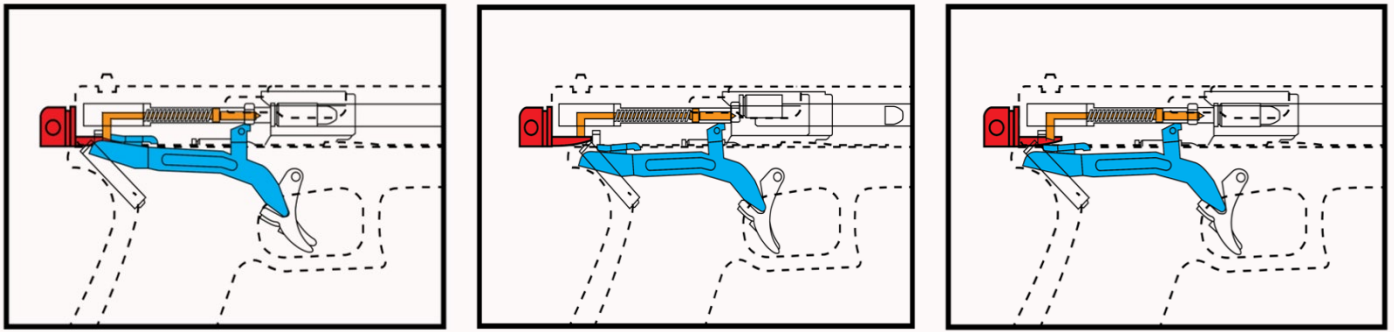

Figure D: Illustration of a semi-automatic Glock handgun equipped with a switch before the trigger pull (left); following the trigger pull, as the striker and slide move backward with recoil (middle); and as the next bullet fires as the Glock switch holds down the trigger bar (right).

46. When equipped with a Glock switch, Glock handguns are machine guns that can fire every bullet in the gun’s magazine with one trigger pull in less than a second, up to 1,200 rounds per minute.

C. Glock Handguns Equipped with Switches Are Destructive, Uncontrollable, and Pose an Unacceptable Risk to Public Safety.

47. Conversion of a Glock handgun from semi-automatic to fully automatic, when equipped with a Glock switch, significantly limits the ability of a shooter to aim and control the gun.

48. With a semi-automatic handgun, a shooter must pull the trigger to fire each individual shot, which allows the shooter time to manage the recoil before another bullet is fired. A fully automatic handgun, however, has virtually no period of delay to control the recoil because the shots from one trigger pull are fired almost instantaneously. Fully automatic handguns are therefore difficult to aim and control, even for trained shooters—increasing the likelihood that shooters will spray bullets indiscriminately, hitting unintended victims or property nearby.

49. The federal Bureau of Alcohol, Tobacco, Firearms and Explosives (“ATF”) Director Steven Dettelbach recently called the proliferation of auto sears “a problem that needs to

be focused on immediately.”⁹ Pete Vukovich, a special agent and chief medic for the ATF in St. Paul, called a Glock handgun with a switch “one of the scariest guns I’ve ever fired in my life.” He explained how after firing one, “[y]ou’ll realize why the roofs in Minneapolis have bullets on them.”¹⁰

50. A police sergeant with the gun investigation unit at the Minneapolis Police Department made a similar observation: “The mere number of rounds that are coming out of these fully automatic firearms are very scary. It’s very dangerous The rounds go everywhere and could hit anybody potentially.”¹¹

51. The former special agent in charge of the ATF’s St. Paul field division emphasized that switch-equipped Glock handguns are “spraying bullets at a rate that is so violent that the person using it can barely control the gun.”¹² Shooters firing switch-equipped Glock handguns “tend to spray and pray,” significantly increasing the likelihood that innocent bystanders may be shot.¹³

52. A sheriff in Cook County, Illinois explained that a switch-equipped Glock is extremely dangerous to bystanders because of the limited control:

There is no way to control that gun when you are firing that gun [equipped with a Glock switch]. . . . Clearly the ability for innocent people to be shot and killed with these things is off the chart. There’s virtually no way this untrained person with a

⁹ Chip Brownlee, *ATF Director Urges Action on Auto Sears ‘Flooding Our Communities’*, Trace (Mar. 1, 2023), <https://www.thetrace.org/2023/03/atf-auto-sears-dettelbach-machine-gun/>.

¹⁰ Stephen Montemayor, *Modern-day Machine Guns*, Star Tribune (Oct. 18, 2023), <https://www2.startribune.com/guns-switches-turning-more-firearms-into-automatic/600312536/>.

¹¹ Ryan Raiche, *A Summer Under (Automatic) Fire*, KSTP (Jan. 15, 2024), <https://kstp.com/kstp-news/top-news/a-summer-under-automatic-fire/>.

¹² Andy Mannix, *Minnesota’s Top Federal Prosecutor Announces Crackdown on Carjackings, Guns and Gangs*, Star Tribune (May 3, 2022), <https://www.startribune.com/minnesota-u-s-attorney-announces-aggressive-crackdown-on-carjackings-gun-violence-and-gangs/600170152>.

¹³ Hunter Saenz, *Authorities raise alarm on device that turns handguns into automatic weapons*, WSOC-TV (Feb. 20, 2023), <https://www.wsocv.com/news/local/authorities-raise-alarm-device-that-turns-handguns-into-automatic-weapons/MH3SRDJ2MVHW7FMNA6K674UHVMM/>.

handgun . . . with a switch on it, is gonna hit the person they're targeting. Most likely, they're going to hit everyone around them, and that's what we see.¹⁴

D. Glock Switches Are Inexpensive and Readily Available.

53. Between 2017 and 2021, the ATF recovered nearly 5,500 conversion devices, including Glock switches—a more than 570% increase over the 814 conversion devices the ATF had recovered in the previous five years.¹⁵

54. Glock switches are available for purchase online, sometimes for as little as \$10 each. One website selling Glock switches provides a “step-by-step guide” to the “relatively simple process that can be completed in just a few minutes” to attach the Glock switch.¹⁶ There are numerous videos available online explaining how to easily equip a Glock switch in just a few minutes.

55. Some overseas Glock switch manufacturers sell their products directly to U.S. consumers through foreign companies like Alibaba (a China-based retailer); other manufacturers do so through U.S. companies. In January 2019, law enforcement recovered five Glock switches from the home of an individual who bought them on Wish.com, a U.S.-based retailer, for \$10 each.¹⁷

¹⁴ Courtney Spinelli, *Chicago Area Law Enforcement Sees Rise in Machine Gun Conversion Device Recoveries*, WGN-TV (Mar. 1, 2023), <https://wgntv.com/news/cover-story/chicago-area-law-enforcement-sees-rise-in-machine-gun-conversion-device-recoveries>.

¹⁵ Bureau of Alcohol, Tobacco, Firearms & Explosives, *National Firearms Commerce and Trafficking Assessment (NFCTA): Crime Guns - Volume Two*, Part VII: Recommendations and Future Enhancements, 4 (2023), <https://www.atf.gov/firearms/docs/report/nfcta-volume-ii-part-vii-recommendations/download>.

¹⁶ *Full Auto Glock Switch Product Page*, Gun Switch (last visited Dec. 11, 2024), <https://gunswitch.org/product/glock-switch/>.

¹⁷ Def.'s Sentencing Mem., *United States v. Abadilla*, No. 19-cr-00072-VC (N.D. Cal. May 3, 2021), ECF No. 44.

56. More recently, Glock switches have also been marketed on social media platforms, where there are also numerous videos and posts demonstrating how to attach them.¹⁸ A 2023 Forbes investigation reported finding Glock switches for sale on Facebook, Instagram, and Twitter.¹⁹

57. Glock switches can also be made using a 3D printer, allowing for the increased domestic manufacture of Glock switches. Online firearms forums acknowledge that “[i]t’s cheap and easy to produce them right here ... [a]nd the plans are available for download to anyone who wants them.”²⁰

E. Glock’s Design of Its Semi-Automatic Handguns Facilitate Their Easy Conversion into Illegal Fully Automatic Machine Guns.

1. Glock’s Semi-Automatic Handguns and Fully Automatic Handguns Have the Same Basic Design.

58. Glock originally designed its semi-automatic handguns for military use. The company’s founder, Gaston Glock, designed the semi-automatic Glock 17 model for the Austrian Army, responding to a request for a new handgun to replace World War II models.

59. Later, the Glock 17 became the first Glock handgun released commercially in the United States. The Glock 17 remains the most popular Glock semi-automatic handgun in circulation today.

¹⁸ Alain Stephens & Keegan Hamilton, *Tiny ‘Glock Switches’ Have Quietly Flooded the US With Deadly Machine Guns*, Vice (Mar. 24, 2022) <https://www.vice.com/en/article/glock-switches-auto-sears/>.

¹⁹ Cyrus Farivar, *It’s Shockingly Easy to Buy Illegal Gun Modifiers on Instagram, Facebook and Twitter*, Forbes (Jun. 28, 2023), <https://www.forbes.com/sites/cyrusfarivar/2023/06/28/its-shockingly-easy-to-buy-illegal-gun-modifiers-on-instagram-facebook-and-twitter/?sh=6254964f67e5>.

²⁰ Dan Zimmerman, *VIDEO: Young Teens Show Off Their Illegal GLOCK Full-Auto Switches, Truth About Guns* (Sept. 29, 2022), <https://www.thetruthaboutguns.com/video-young-teens-show-off-their-illegal-glock-full-auto-switches/>.

60. The Glock 17 design remains the foundation of Glock’s handgun business. New Glock handgun models are generally typified by differences in size, differences in ammunition used, or both, without significant changes to mechanics or core features. Popular Glock handgun models in the United States include the G19 (a compact frame that shoots 9mm) and the G22 (a .40 caliber with a standard-sized frame). Over the years, Glock has also issued updated “generations” of certain models—from the original Gen1 to the latest Gen5—featuring minor changes, such as adding finger grooves to the grip.

61. Glock’s semi-automatic handguns have the same basic design as Glock’s fully automatic handguns, which are not authorized for sale to civilians. Glock manufactures a fully automatic handgun, the Glock 18. Glock based the design of the Glock 18 on the Glock 17. The Glock 18 is a variation of the Glock 17, with a “selector switch” on its side. The selector switch allows the Glock 18 to switch between semi-automatic and fully automatic firing.

62. A side-by-side comparison of the Glock 17 and the Glock 18 on Glock’s website demonstrates the similarity in their design.²¹



²¹ *GLOCK compare pistols*, Glock, <https://eu.glock.com/en/Products/Pistols> (last visited Dec. 11, 2024).

63. Glock promotes the Glock 18 and Glock 17 design similarity. Glock’s website touts that the Glock 18 “has the same characteristics like other previous models and the frame size of the service pistol classic G17.”²² Glock also promotes another version of the Glock 18, the Glock 18C, as having “the frame size of the original model G17.”²³

64. The design similarity between the semi-automatic Glock 17 and fully automatic Glock 18 illustrates why converting semi-automatic Glock handguns into fully automatic machine guns is so easy and prevalent. Only a minimal adjustment, accomplished with the Glock switch, is required to convert Glock 17 handguns into fully automatic machine guns. Glock itself developed the fully automatic Glock 18 from Glock 17’s basic design, including adding a selector switch.

65. Today, Glock produces and sells the fully automatic Glock 18 handgun to law enforcement and the military. The Glock 18 is illegal to purchase by civilians because it is a machine gun.

66. Glock knows that fully automatic versions of its handguns are difficult to aim and control—particularly when used by individuals without specialized training.²⁴ Gaston Glock “enjoyed showing off” the fully automatic Glock 18 to police officers and other potential customers.²⁵ During these demonstrations, “[m]any an embarrassed police officer inadvertently peppered the ceiling of the company shooting range with rounds.”²⁶

²² *G18*, Glock, <https://eu.glock.com/en/products/pistols/g18> (last visited Dec. 11, 2024).

²³ *Id.*

²⁴ Nick Oetken, *What’s Inside a Glock 18 Pistol*, GunZone (Feb. 17, 2024), <https://thegunzone.com/whats-inside-a-glock-18-pistol/>.

²⁵ Paul M. Barrett, *Glock: The Rise of America’s Gun* 60 (2012).

²⁶ *Id.*

2. Glock Promotes Its Uniquely “Simple” and “Easy” Design, Which Enables Its Semi-Automatic Handguns to Be Easily Converted into Illegal Fully Automatic Machine Guns.

67. Glock’s self-described “simple” and “easy” handgun design makes it particularly easy to access internal parts and systems and attach accessories and thereby promotes the conversion of Glock semi-automatic handguns into illegal, fully automatic machine guns.²⁷

68. That Glock’s simple handgun design facilitates easy conversion to illegal, fully automatic machine guns with Glock switches is widely known and has been widely reported.²⁸ The primary feature of Glock handguns that Glock markets and promotes—“Glock’s internal design, which makes Glock parts easy to access and modify”—is also what renders Glock handguns so easy to convert into fully automatic machine guns.²⁹

69. Glock showcases the simplicity of its handgun design in its marketing materials and on Glock’s website. Glock’s website celebrates that its handguns are “manufactured with only 34 component parts, significantly less than our competitors’ semi-automatic pistol designs.”³⁰ Glock also emphasizes the uniqueness of its “simple” design relative to other semi-automatic handgun manufacturers.³¹

²⁷ *Glock Technology*, Glock, <https://us.glock.com/en/learn/glock-pistols/technology> (last visited Dec. 4, 2024).

²⁸ Champe Barton, *Glock Could Make It Harder to Outfit Its Pistols With Switches — For a Price*, *The Trace* (Sept. 4, 2024), <https://www.thetrace.org/2024/09/glock-switch-lawsuits-pistol-design/>.

²⁹ Alain Stephens & Keegan Hamilton, *Tiny ‘Glock Switches’ Have Quietly Flooded the US With Deadly Machine Guns*, *Vice* (Mar. 24, 2022), <https://www.vice.com/en/article/glock-switches-auto-sears/>.

³⁰ *Glock Technology*, Glock, <https://us.glock.com/en/learn/glock-pistols/technology> (last visited Dec. 4, 2024).

³¹ *Id.*

70. Glock brags about how easy it is to disassemble its guns, claiming that “[t]he design of GLOCK modern firearms enables them to be field stripped into four main components without tools in seconds.”³²

71. Glock encourages its customers to leverage Glock’s handgun design to customize their firearms. With Glock’s knowledge and approval, Glock users equip their handguns with a range of aftermarket accessories and parts.³³ Glock also knows its customers modify the Glock handgun slide and slide cover plate using aftermarket products.³⁴

72. Glock’s website advertises how easy it is to customize Glock handguns. Glock’s website tells users, in all caps, to “PERSONALIZE YOUR GLOCK TO YOUR OWN STYLE!”³⁵ Glock’s website promotes how Glock offers “a wide array of customization options, allowing you to tailor your firearm to your specific needs and personal preferences.”³⁶

73. For years, Glock has encouraged companies to develop accessories and aftermarket parts for its handguns. Companies such as “RockYourGlock”³⁷ and “GlockStore”³⁸ use Glock’s trademarked name to encourage customers to equip their Glock handguns with a range of aftermarket accessories and parts. GlockStore, an online gun retailer not directly affiliated with Glock that uses Glock’s trademark in the name of their business, calls itself “The World’s #1 Source For Glock Parts & Accessories.”³⁹ GlockStore tells users to “Make your Glocks special

³² *Id.*

³³ Excerpt of Deposition of Carlos Guevara Pursuant to Fed. R. Civ. P. 30(b)(6), *Oglesbee v. Glock, Inc.*, No. 18-cv-560 (N.D. Okla. May 22, 2023) ECF No. 283-3 at 185:4-9; 66:3-9.

³⁴ *Id.*

³⁵ *Glock Options*, Glock, <https://eu.glock.com/en/Products/GLOCK-Options> (last visited Dec. 6, 2024).

³⁶ *Id.*

³⁷ *Custom Glock Shop*, ROCKYOURGLOCK, <https://rockyourglock.com/custom-glock-shop/> (last visited Dec. 7, 2024).

³⁸ *Customize*, GLOCKSTORE, <https://www.glockstore.com/customize> (last visited Dec. 7, 2024).

³⁹ *Id.*

with custom Glock modifications from GlockStore” and promotes custom finishes and parts, including customized slide cover plates.⁴⁰

74. The trend of equipping Glock handguns with accessories and aftermarket parts has become so popular that Glock handguns equipped this way are now colloquially known as “Gucci Glocks.” “Gucci Glocks” can be found all over social media. For example, there is a dedicated Instagram account called “Gucci_Glocks” that self-describes as “The premier page for #glockporn. Follow to see the most badass Glocks on IG daily.”⁴¹

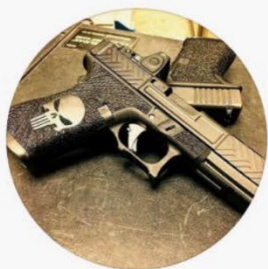

103
posts

2,660
followers

8
following

Gucci Glocks

The premier page for #glockporn. Follow to see the most badass Glocks on IG daily. Tag @gucci_glocks and use #gucciglocks for a repost/feature.

75. Glock has run several social media campaigns encouraging customers to share how they have personalized their Glock handguns. One Facebook post asked “all GLOCK enthusiasts” to “submit your own GLOCK photo using #MyGLOCK” for the chance for their photographs of their handguns to be featured in Glock’s print calendar.⁴² Several users replied to this post with photographs of Glock handguns equipped with aftermarket parts. One user submitted a photograph

⁴⁰ *Id.*

⁴¹ Gucci_Glocks (@gucci_glocks), Instagram, https://www.instagram.com/gucci_glocks/?hl=en (last visited Dec. 7, 2024).

⁴² *Give Us Your BEST SHOT*, Facebook (Mar. 25, 2016), <https://www.facebook.com/GLOCK>.

of their Glock 19 handgun: “Custom g19 slide milling polished internals complete 3.5 trigger setup. Extended slide and mag release. Undercut for better grip, mag well cut for reloads. Night sites. Shoots like a dream.”

76. Another user submitted a picture of a Glock handgun that they claimed had been converted to fire fully automatically and appears to be equipped with a Glock switch. The user claimed the handgun was a “full auto Glock 19:”



Alex Robinson
#MYGLOCK My fathers full auto Glock 19



77. Glock made another Facebook post asking users to describe themselves as their Glock handguns: “There are many great guns out there, but this one is yours. Which GLOCK are you?”⁴³ In response, users submitted descriptions and pictures of their Glock handguns. Several of these user responses stated that they have customized their Glock handgun with aftermarket parts. One user wrote “I’m a gen3 G19 w/ Glock Night Sights, with custom dragon scale grip modification, shaved down grip hump, and a nice trigger job.” Another user wrote “Glock 23 with an Alpha wolf 9mm conversion barrel.” Another user wrote “Love my 29 also . . . put in a tungsten guide rod with a 21 lb spring for the snappier loads . . . just waiting for my alpha wolf barrel and all will be right in the world!”

⁴³ *Which GLOCK are you?*, Facebook (Oct. 20, 2016), <https://www.facebook.com/GLOCK>.

78. Glock responded to this thread of user submissions on this Facebook post: “Hi GLOCK fans. We wanted to give you a shout out for your feedback and participation on this post. We love to see our fans’ enthusiasm...keep it coming.”

79. In another Facebook post, Glock asked its users “What do you like most about the design of your GLOCK?”⁴⁴ Several users responded by highlighting how Glock’s design allows for easy customization. One user wrote “I like that there is very little about the gun that I haven’t been able to customize, that you don’t have to be a gunsmith to tear it completely apart to access every internal piece. Simplicity.” Another user wrote “After market parts are usually pretty affordable . . . I like the interchangeable components between pistols.”

80. Most alarmingly, users told Glock that what they liked most about Glock’s handgun design was how easy it was to convert it to a fully automatic machine gun. One user commented on the ability to fire fully automatically: “I love glock 18c rate of fire and just everything.” Another user wrote “you can make with the cool accesorries [sic] full auto the GLOCK pistol ☺.”



Juan Mercurio

you can make with the cool accesorries full auto the GLOCK pistol ☺

81. Online forums among Glock owners and enthusiasts further demonstrate how Glock’s handgun design facilitates the conversion of its semi-automatic handguns into illegal, fully automatic machine guns.

82. On GlockForum.net, one user posted that a Glock switch could be attached to a Glock handgun in minutes after the slide was taken apart by an experienced armorer. Then another user responded to clarify the ease of conversion: “What? For a Glock? No . . . it’s a 10 *second* job

⁴⁴ *What do you like most about the design of your GLOCK?*, Facebook (Aug. 5, 2015), <https://www.facebook.com/GLOCK>.

to slip out the back plate and even less time to replace it with the sear. No ‘taking the slide apart’ and no ‘armorer’ needed.”⁴⁵

83. On another online forum, a user explained how simple it is for a person to attach a Glock switch: “So easy a child can do it.”⁴⁶

84. ATF agents have testified that Glock switches “are designed especially for Glock firearms” and that they can be attached without any specialized training.⁴⁷

3. Specific Features in Glock’s Design of Its Semi-Automatic Handguns Facilitate Their Easy Conversion into Illegal, Fully Automatic Handguns.

85. At least two specific design features of Glock semi-automatic handguns allow them to be easily converted into machine guns.

86. First, the design of the slide cover plate allows it to be easily removed and replaced with a Glock switch.

87. The slide cover plate is a small plastic piece on the back of the slide, which is the upper part of the handgun that “slides” backwards with recoil. Unlike those of many other gun manufacturers, Glock’s slide cover plate can be easily removed in seconds, without any tools, and with no expertise. A Glock switch can then be easily attached to convert a semi-automatic handgun into a fully automatic machine gun.⁴⁸

⁴⁵ Thewolfchild, Comment to *Glock full auto*, GlockForum.net (Aug. 12, 2015), <https://www.glockforum.net/threads/glock-full-auto.10958> (emphasis in original).

⁴⁶ ThurstonLast, Comment to *I’m skeptical – criminals supposedly easily convert glocks to full auto*, Reddit, https://www.reddit.com/r/Firearms/comments/xbqo7m/im_skeptical_criminals_supposedly_easily_convert/?rdt=40623 (last visited Dec. 6, 2024).

⁴⁷ Test. of ATF Agent Michael Powell, *United States v. Williams*, No. 16-cr-89 (N.D. Fl. Mar. 7, 2017).

⁴⁸ Bureau of Alcohol, Tobacco, Firearms and Explosives, ATF Firearms & Ammunition Technology Division Technical Bulletin 17-04 (2017), *United States v. Freitas*, No. 20-cr-223 (N.D. Cal. May 29, 2020), ECF No. 42, Ex. 5.

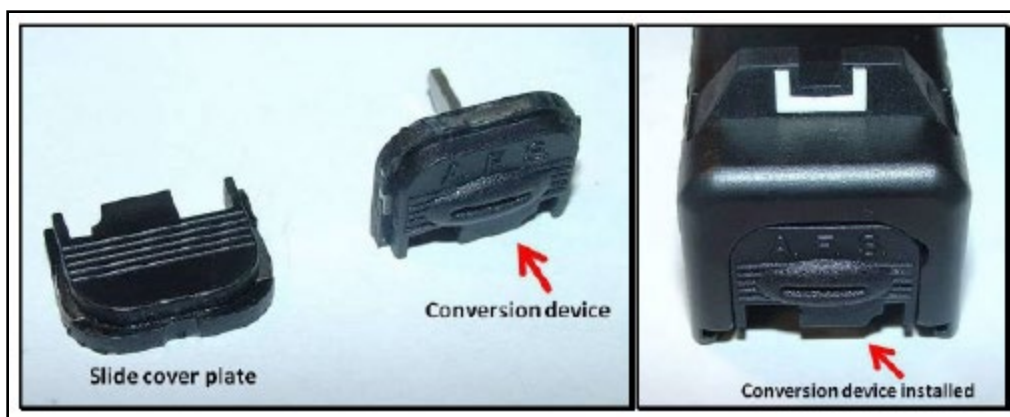

88. Glock designed its slide cover plates to be easily removed without any tools or training. Glock’s slide cover plate “drops right in to your slide” with “no tools required.”⁴⁹

Description

 Made in USA

The Glock® Gen5 Slide Cover Plate is a factory replacement part for the plate at the back of your Gen5 pistol’s slide. Glock’s Gen5 Slide Cover Plate **drops right in to your slide - no tools required** - to replace a broken, scratched, scuffed, cracked, or otherwise less-than-pretty original. The Glock® Gen5 Slide Cover Plate is molded from black polymer to match the rest of the slide, with a reinforcing stainless steel insert for strength.

89. If Glock were to require specialized tools and training to remove the slide cover plate or were to make the plate unremovable, converting Glock’s handguns to fully automatic machine guns would be far more difficult.

90. Second, Glock also facilitates the conversion of its semi-automatic handguns into machine guns through its trigger bar system design, which is easily accessible and manipulable.

91. When the trigger on a Glock semi-automatic handgun (not equipped with a Glock switch) is pulled back, the trigger bar releases the striker to fire one bullet. The trigger bar then immediately returns to its original position, preventing the striker from being released to fire a second bullet. This ensures that the gun fires only one bullet per trigger pull. In short, the trigger

⁴⁹ *Slide Cover Plate G17/G19 9mm Gen 5 Black*, Brownells, <https://www.brownells.com/gun-parts/handgun-parts/handgun-slides-parts/slide-cover-plate-gen5/> (last visited Dec. 11, 2024).

bar both initiates the firing of one bullet and then springs back into place to restrain additional firing.

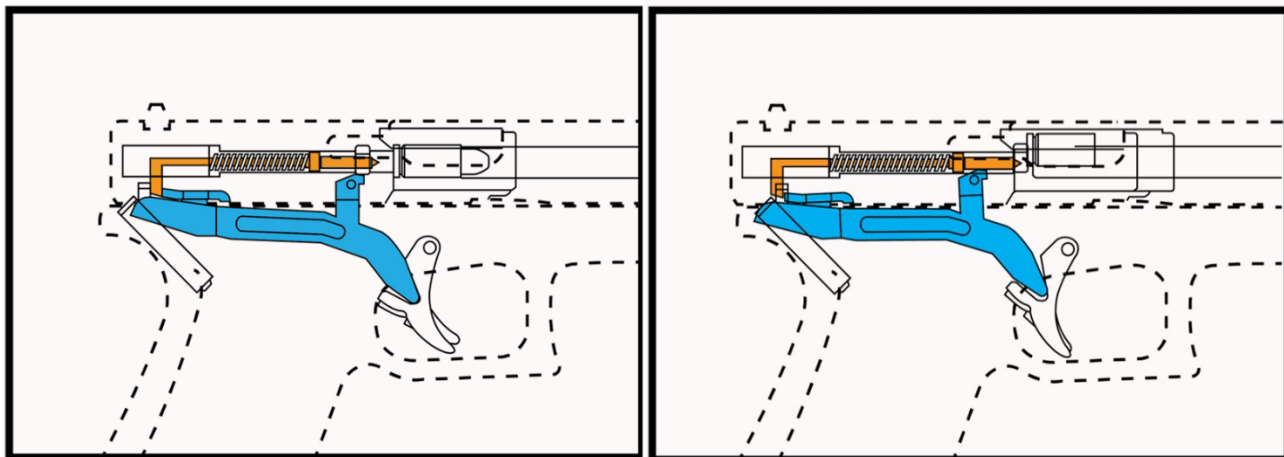

Figure E: Illustration of a semi-automatic Glock handgun before firing (left) and after firing while the trigger is still held down, with the trigger bar preventing the striker from moving forward (right).

92. Glock’s trigger bar system makes its handguns more susceptible to conversion to fully automatic machine guns than most other striker-fired handguns. Other striker-fired handguns contain independent trigger bars and sears that are separated from the back of the gun by a “rear rail.” This “rear rail” blocks the exact location where the “disconnecter” of an auto sear would otherwise go.

93. In contrast to other striker-fired handguns, a Glock handgun combines the functions of a trigger bar and a sear into one piece—the trigger bar. Glock’s trigger bar design provides a relatively large surface area for a Glock switch’s disconnecter to target. In addition, nothing shields the large cross-shaped portion of the trigger bar from the back of a Glock handgun, making it possible for a Glock switch’s “disconnecter” to slide between the trigger bar and the striker to contact the trigger bar and push it downward so that the Glock can continue firing with only one pull of the trigger.

94. Glock could redesign its trigger bar system to make it more difficult to convert Glock semi-automatic handguns into illegal fully automatic machine guns with Glock switches. But Glock has chosen not to do so.

95. Instead, Glock markets its trigger bar system as a safety feature of its handguns. Glock claims its trigger bar system acts as an internal safety for its guns.

96. Unlike handguns offered by most manufacturers, Glock handguns do not have a traditional external safety. Instead, Glock’s handgun design uses a three-part trademarked internal “safety” system called the Safe Action System. According to Glock, this system is comprised of three internal “independently-operating mechanical safeties.”⁵⁰ One of these three internal “safeties” is the trigger bar system, which Glock calls the “drop safety.”



97. Glock claims that its trigger bar system makes its guns safer, marketing its trigger bar system as a key part of Glock’s trademarked SAFE ACTION System. In reality, however, the design of Glock’s trigger bar system makes its handguns easier to convert into fully automatic machine guns than other semi-automatic handguns sold by Glock’s competitors.

⁵⁰*Our Safe Action System*, GLOCK, <https://us.glock.com/en/learn/glock-pistols/safe-action-system> (last visited Dec. 11, 2024).

98. In fact, numerous online forums discuss the use of Glock’s internal safety system and the conversion of Glock handguns to fully automatic weapons. In a Reddit post discussing Glock switches, a user described how Glock’s SAFE ACTION System facilitates the easy attachment and functionality of Glock switches. The user wrote “What is funny is that the Glock safe firing mechanisms are what allows the switch to work and to be so simple.”⁵¹

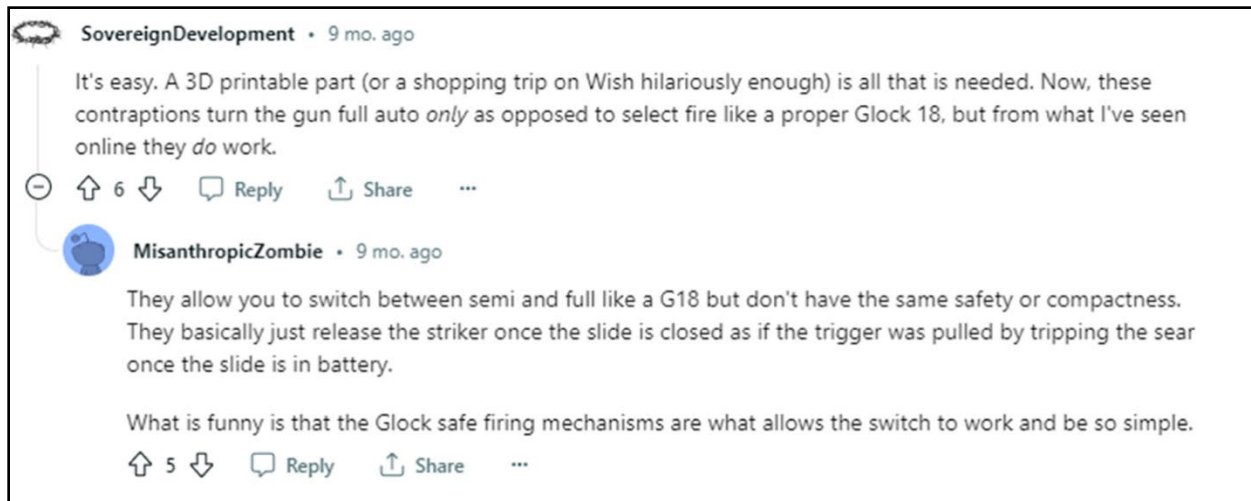

4. Glock Could Make Design Changes to Deter the Conversion of Glock Semi-Automatic Handguns into Illegal Fully Automatic Handguns.

99. Glock has told law enforcement officials that its handguns’ designs cannot be changed to make attaching Glock switches more difficult.⁵² But Glock’s past practices show otherwise.

⁵¹ MisanthropicZombie, Comment to *I’m skeptical – criminals supposedly easily convert glocks to full auto*, Reddit, https://www.reddit.com/r/Firearms/comments/xbqo7m/im_skeptical_criminals_supposedly_easily_convert/ (last visited Dec. 6, 2024).

⁵² Ernesto Londoño & Glenn Thrush, *Inexpensive Add-on Spawns a New Era of Machine Guns*, N.Y. Times (Aug. 12, 2023), <https://www.nytimes.com/2023/08/12/us/guns-switch-devices.html>.

100. In or around August 2017, Glock released a “fifth generation” design for several of its semi-automatic handguns, including the Glock 17 and Glock 19. The “Gen 5” Glock handguns included a change to the design of the rear of the frame to include a small tab sticking up to the slide cover plate for the Gen 5 (shown on the left below) that was missing from earlier models like the Gen 4 (shown on the right).⁵³

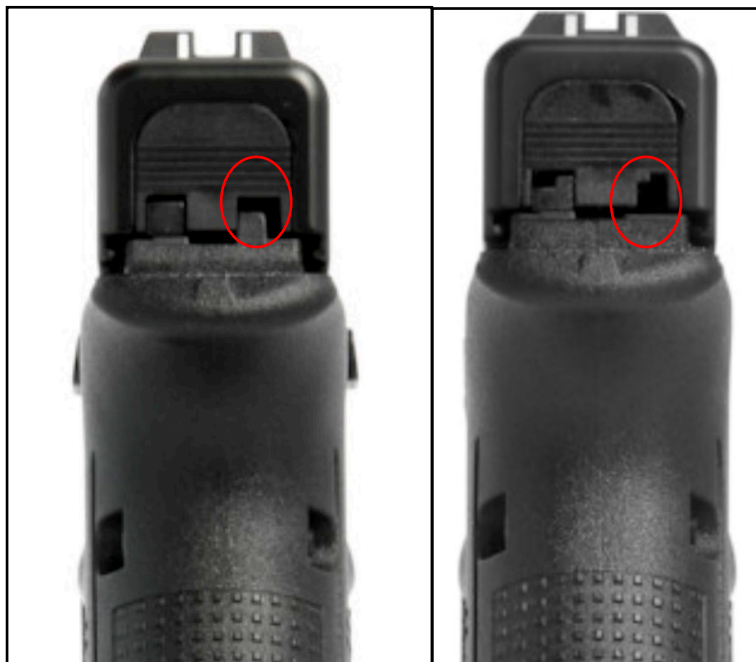

101. Glock has not stated publicly that this tab was added in response to concerns about Glock switches. But the tab makes attaching Glock switches slightly more challenging and has no other evident purpose.

102. Unfortunately, the tab is so easy to remove that it has failed to have any meaningful effect on the ease of attachment of Glock switches and their proliferation. The tab can be easily

⁵³ Compare *G17 Gen 5*, Glock, <https://us.glock.com/en/pistols/g17-gen5-fs-us> (last visited Dec. 6. 2024) (screenshot generated using 3D rotation feature), with *G17 Gen 4*, Glock, <https://us.glock.com/en/pistols/g17-gen4> (last visited Dec. 6. 2024) (same). See also *Glock Gen 5 & 4 Detailed Comparison*, YouTube, <https://www.youtube.com/watch?v=QksiKWDBtQs> (last visited Dec. 6. 2024).

filed down using a metal file without technical knowledge or specialized tools. Glock's Gen 5 handguns remain essentially as easy to convert to fully automatic machine guns as previous models.

103. In fact, in the time since Glock made this change, Glock switches have exploded in popularity despite the tab's addition.

104. Although adding the tab was and continues to be ineffective in thwarting conversion of Glock handguns into illegal fully automatic machine guns, this change shows that Glock has been aware of the problem of Glock switches for years and could have made additional, more effective design changes.

105. A Glock handgun that is not susceptible to the use of switches—the G46—also shows that Glock could thwart conversion of its handguns into illegal fully automatic machine guns. Glock's G46 handgun design has a backplate and striker that comprise one single metal piece, such that the backplate cannot be removed to attach a switch without altogether disabling the gun.

F. Glock Encourages Conversion of Its Semi-Automatic Handguns by Promoting Its Fully Automatic Handguns.

106. Even though the Glock 18 is generally illegal to sell and purchase, Glock promotes fully automatic handguns to the public as exciting and “fun.”

107. On Glock’s Instagram account, Glock featured a video of a shooter firing a Glock 18, proclaiming “the only thing more fun than a GLOCK is full-auto GLOCK.”⁵⁴



108. Glock’s social media post does not indicate that owning or firing the Glock 18 is generally unlawful for regular consumers in the United States because it is a fully automatic machine gun.

⁵⁴ GLOCK, Inc. (@glockinc), Instagram, <https://www.instagram.com/glockinc> (last visited Dec. 7, 2024).

109. In a 2023 social media post celebrating the New Year, Glock posted a video of someone firing both semi-automatic and fully automatic Glock handguns. As the video counts down from ten, the shooter fires the corresponding number of bullets from a semi-automatic Glock handgun. As the countdown reaches one, the shooter fires a fully automatic Glock handgun with bullets emerging in rapid succession. The post does not identify the firearm shot in the video as a Glock 18 unavailable to the civilian public. Rather, the video suggests that this form of “ringing in the New Year” is possible and legal for anyone.⁵⁵

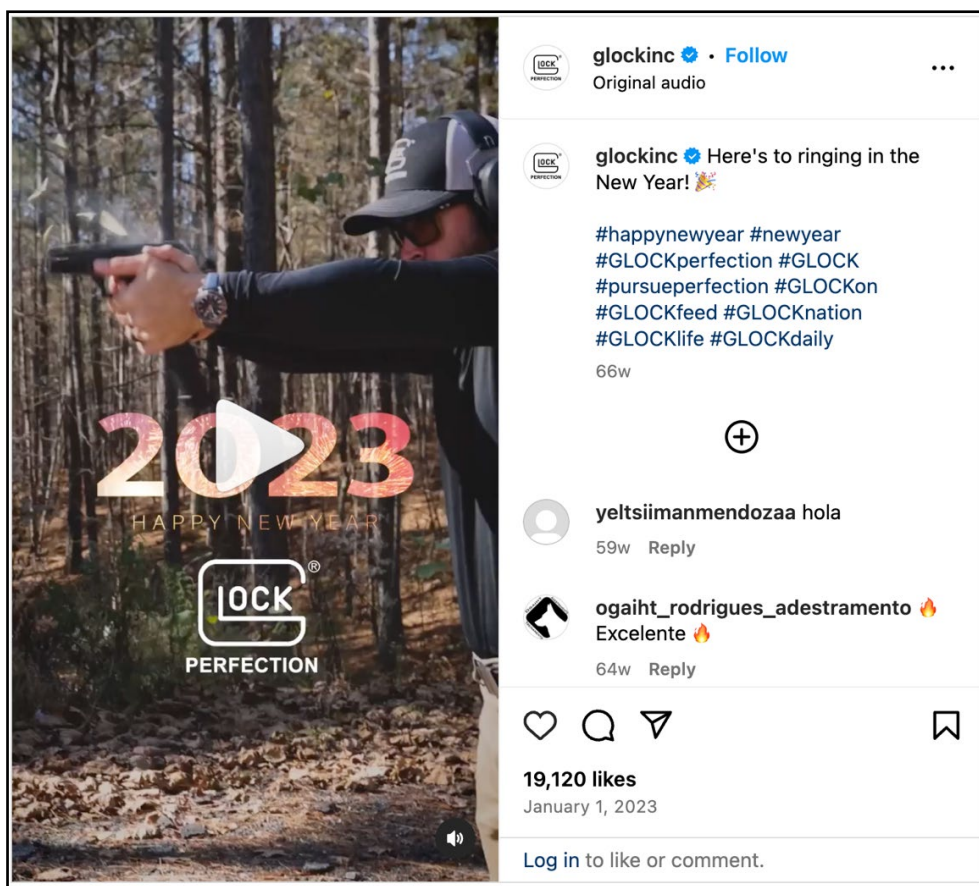

110. In other posts on social media, Glock has displayed images of the Glock 18 and the Glock 18C with language glorifying fully automatic Glock handguns: “Double your pleasure.

⁵⁵ GLOCK, Inc. (@glockinc), Instagram, <https://www.instagram.com/glockinc> (last visited Apr. 9, 2024).

Double your fun. #GLOCK #2A #GlockPerfection #G18 #fullauto” and “The G18C in all its glory . . . #GlockPorn.”⁵⁶

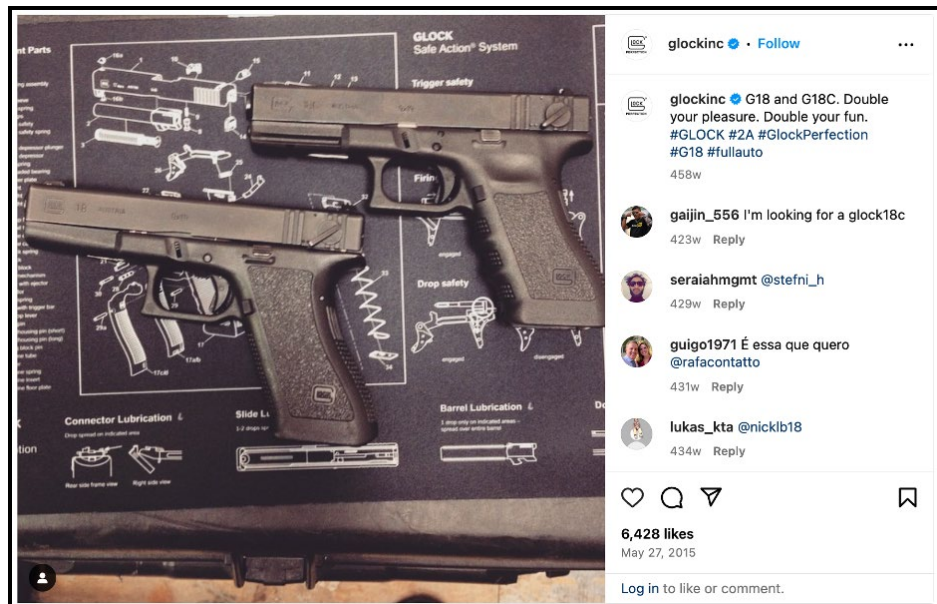
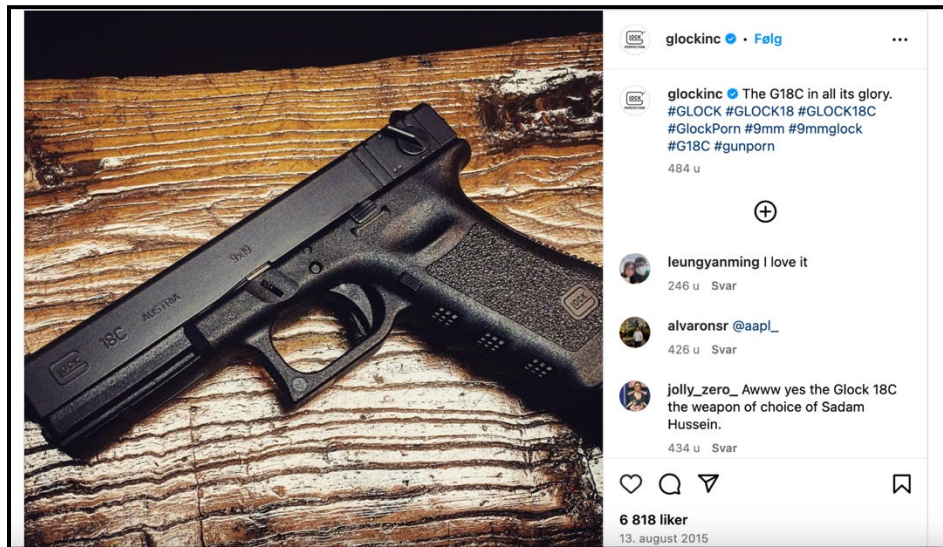

111. Glock continues to show the Glock 18 to visitors at the company’s United States headquarters in Smyrna, Georgia as “a Glock marketing practice.”⁵⁷ One video shows the Glock

⁵⁶ GLOCK, Inc. (@glockinc), Instagram, <https://www.instagram.com/glockinc> (last visited Nov. 26, 2024).

⁵⁷ Paul M. Barrett, *Glock: The Rise of America’s Gun* 60 (2012).

USA Rangemaster shooting the Glock 18C and showing off its features to headquarters visitors. Pointing to the selector switch that turns the gun to fully automatic, the rangemaster says, “Here’s the, what we call the ‘fun switch,’ that’s one of the names for it.” The rangemaster later shows off firing the G18C one-handed, and visitors are given the chance to fire the G18C themselves.⁵⁸

II. Glock Knows Its Semi-Automatic Handguns Are Being Converted into Illegal Machine Guns with Glock Switches—But Glock Has Refused to Change the Design.

112. Glock knows that its semi-automatic handguns are easily and frequently converted to illegal, fully automatic machine guns with Glock switches, and Glock knows that these fully automatic handguns present a significant threat to public safety.

113. Glock even knows that Glock switches often bear Glock’s trademarked logo and company name despite being illegal and manufactured by other parties. But Glock has failed to stop infringing use of its trademarks on switches. Glock is aware that some of its own customers even believe that Glock manufactures Glock switches, but Glock has failed to warn consumers that Glock switches are illegitimate and illegal.

114. Glock’s own social media posts include comments from others promoting Glock switches. But Glock has not deleted or responded to such comments to clarify that Glock switches are illegal and dangerous.

115. Glock does not include disclosures on its handguns, instruction manuals, or marketing materials warning purchasers that converting a semi-automatic handgun to a fully automatic machine gun is illegal.

⁵⁸*The Full Auto Glock 18C Machine Pistol*, YouTube, <https://www.youtube.com/watch?v=cc4ZTIsusTQ> (last visited Dec. 6, 2024).

A. Glock Knew—and Demonstrated—that Its Semi-Automatic Handguns Could Be Easily Switched into Illegal Machine Guns Nearly 40 Years Ago.

116. In September 1987, a Venezuelan mechanical engineer and gunsmith named Jorge Leon invented a “fire selector system” for use on the Glock 17. The fire selector system manufactured by Mr. Leon’s business used a similar design to many of the Glock switches commonly found in use today.

117. Due to Mr. Leon’s work in the Venezuelan firearms industry during the 1980s, he was invited to a demonstration of the Glock 17 on April 13, 1988. The demonstration took place at a shooting range in Venezuela during the afternoon. Gaston Glock—the founder of Glock—attended and participated in the demonstration.

118. During the demonstration, Gaston Glock personally demonstrated firing the Glock 17. At one point during Mr. Glock’s demonstration, after firing the pistol in a standard semi-automatic configuration, Mr. Glock paused and quickly attached a small auto sear that he had in his pocket to the back of the pistol. Mr. Glock did so by removing the slide back plate on the handgun and inserting the auto sear, and he then proceeded to demonstrate fully automatic fire using the same gun.

119. After Mr. Glock’s demonstration, Mr. Leon met Mr. Glock and examined the auto sear used by Mr. Glock during the demonstration. Mr. Leon observed that the auto sear was made of metal, with an appearance suggesting the auto sear had been manufactured using metal injection molding. Mr. Glock’s auto sear lacked the mechanism present on Mr. Leon’s fire selector system that allows a user to choose between semi-automatic and fully-automatic fire.

120. About a week after Mr. Glock’s demonstration of the Glock 17’s ability to be easily converted with an auto sear into a fully automatic machine gun, Mr. Leon met Mr. Glock for breakfast at Mr. Glock’s hotel. After breakfast, Mr. Leon allowed Mr. Glock to examine an early

version of the fire selector system Mr. Leon had invented, which, like the auto sear used by Mr. Glock earlier, allowed a semi-automatic Glock handgun to fire fully automatically when attached. After examining the fire selector system, Mr. Glock advised Mr. Leon to stop development on the device and to “leave it as a curiosity.”

121. Mr. Leon’s interactions with Mr. Glock demonstrate that Glock has been aware of how its handgun designs allow for easy conversion into fully automatic machine guns for almost four decades.

B. Glock Knows Today That Its Semi-Automatic Handguns Can Be and Are Being Turned into Illegal Fully Automatic Machine Guns with Glock Switches.

122. Glock knows that many of its semi-automatic handguns are easy to convert into machine guns with Glock switches and that they are being converted throughout the United States, including in Minnesota.

1. Glock Knows That Switches Are Being Sold and Being Branded with Glock’s Intellectual Property.

123. In 2019, the Department of Homeland Security (DHS) contacted Glock as a part of an investigation into illegally imported Glock switches.⁵⁹ DHS agents spoke with a Glock employee, who admitted that Glock is aware of Glock switches being offered for sale on the internet, including on websites like eBay.⁶⁰

⁵⁹ See Aff. of Michael Thomas, *United States v. Keller*, No. 21-cr-871 (N.D. Ohio Nov. 18, 2021), ECF No. 1-1.

⁶⁰ Though the employee stated that Glock was working with eBay to remove ads for Glock switches with its logo, the employee did not state that Glock was taking any steps to prevent the easy conversion of its semi-automatic handguns to fully automatic, and, even today, Glock switches continue to be advertised across the Internet and social media platforms. *See id.*

124. As reported by The Trace, “Glock switches have become so popular that unwitting customers have mailed them to the company’s headquarters for repairs.”⁶¹

125. Confusion about the source of Glock switches makes sense, because many Glock switches are branded with Glock’s trademarked logo.⁶²



126. Despite the proliferation of Glock switches bearing Glock’s logo, Glock has failed to stop companies producing these illegal products from using Glock trademarks. Consumers may believe that Glock switches are legal and safe because they bear the Glock logo.

127. On August 22, 2022, Glock’s general counsel forwarded an email from Glock’s outside intellectual property counsel to an ATF employee detailing Glock’s intent to send cease-and-desist letters to someone selling Glock switches on Instagram and YouTube. The email explicitly shows Glock’s knowledge “regarding the infringement of GLOCK’s intellectual property and the sales of illegal full auto switches.”

128. Despite Glock’s knowledge of the infringement of Glock’s intellectual property rights with Glock switches, Glock switches branded with Glock’s logo remain readily available. Glock further refuses to fix the underlying design of its handguns to prevent the use of such Glock switches that use the Glock logo.

⁶¹ Chip Brownlee, *ATF Director Urges Action on Auto Sears ‘Flooding Our Communities’*, Trace (Mar. 1, 2023), <https://www.thetrace.org/2023/03/atf-auto-sears-dettelbach-machine-gun/>.

⁶² *United States v. Freitas*, No. 20-cr-223 (N.D. Cal. May 29, 2020), ECF No. 42, Ex. 1.

2. Nationally Reported Shootings Perpetrated with Handguns Equipped with Glock Switches Have Led to Government Action.

129. Glock is also plainly aware that its semi-automatic handguns are being turned into illegal machine guns with Glock switches based on widespread reporting about shootings involving Glock switches and government actions to address the problem.

130. On November 2, 2021, U.S. Senators Amy Klobuchar and Cory Booker issued a public letter calling on Attorney General Merrick Garland to take action against the “proliferation” of auto sears and fully automatic guns. Although “the Department of Justice [had already] prosecuted numerous people for illegally possessing conversion devices and converting semi-automatic firearms into fully automatic weapons,” the proliferation was contributing to the “rise” of “[g]un related homicides.”⁶³

131. In April 2022, a shooting on a crowded street in downtown Sacramento, California was carried out with a Glock handgun equipped with a Glock switch. The shooting killed six people and wounded 12, and police recovered more than 100 cartridge casings at the scene. In response to this tragedy, 40 members of Congress signed another letter urging action against the proliferation of fully automatic Glock handguns. The letter was publicly released and called out Glock specifically. Representative Jake Auchincloss, who signed the letter, succinctly explained Glock’s responsibility: “If they know that their Glocks can be retrofitted with auto sears that easily, and they’re not preventing it with simple design changes, that becomes a product liability.”

132. Glock did not change its semi-automatic handgun design after receiving the letter.

⁶³ Letter from Sen. Amy Klobuchar, U.S. Senate, and Sen. Cory A. Booker, U.S. Senate, to Merrick Garland, U.S. Att’y Gen., U.S. Dep’t of Just. (Oct. 25, 2021), https://www.klobuchar.senate.gov/public/_cache/files/8/5/85995b61-ac5a-47a1-99ea-3f86d2d12c4f/7B303332BDF415CE6FFD12D8A97A59D8.letter-from-sen.-klobuchar-and-sen.-booker-to-ag-garland-re-auto-sears-and-other-conversion-devices-dated-10.25.2021-final-.pdf.

133. More shootings involving Glock handguns converted into fully automatic machine guns with Glock switches occurred later the same year. In May 2022, nine people were shot—some multiple times—in a mass shooting with a Glock 19 equipped with a switch in the highly trafficked Magnificent Mile district of Chicago.

134. Just months later, in September 2022, multiple Houston, Texas police officers were injured and killed in two shootings perpetrated with Glock handguns converted into fully automatic weapons with Glock switches. In one of these shootings, a suspect who had been pulled over in a traffic stop wounded three police officers in seconds. The same month, a shooter shot at two officers approaching his home to execute an arrest, killing one officer and wounding the other officer.

135. On March 19, 2024, the City of Chicago sued Glock to hold Glock accountable for making and selling handguns that are easily turned into machine guns with Glock switches.⁶⁴

136. On March 26, 2024, the Minnesota Attorney General, together with the New Jersey Attorney General and the Attorneys General of ten other states and the District of Columbia, sent Glock a letter demanding that Glock do something to address the “mounting reports about devastation and public terror caused by Glock handguns that became illegal machine guns when fitted with cheap, ubiquitous inserts known as ‘switches’ or ‘auto-sears.’”⁶⁵

137. On September 21, 2024, in Birmingham, Alabama, several people opened fire with handguns equipped with Glock switches, killing four people and injuring 17 others. The shooting’s

⁶⁴ Compl., *City of Chicago v. Glock, Inc.*, No. 2024CH02216 (Cir. Ct. Cook Cnty. Mar. 19, 2024). Chicago withdrew and refiled its suit against Glock in June 2024. Compl. ¶¶ 133–82, *City of Chicago v. Glock, Inc. et al.*, No. 2024CH06875 (Cir. Ct. Cook Cnty. July 22, 2024).

⁶⁵ Letter from Att’y Gen. Keith Ellison et. al., to Carlos Guevara, General Counsel, Glock, Inc. (March 26, 2024), https://www.ag.state.mn.us/Office/Communications/2024/docs/Glock_MultistateLetter.pdf.

aftermath was like a “horror movie.” Over 100 shell casings were recovered. Law enforcement believe the shooters’ use of Glock switches enabled them to quickly release a barrage of bullets.⁶⁶

138. Following the Birmingham attack, President Biden issued an Executive Order on September 26, 2024, signaling the severity of the threat posed by Glock switches. The Executive Order established the Emergency Firearms Threats Task Force, tasked with developing “a risk assessment and strategy to stop the proliferation of machinegun conversion devices, with a particular emphasis on the devices used to convert a standard, semiautomatic firearm to a machinegun.”⁶⁷

139. On November 10, 2024, a switch-equipped Glock handgun killed an 18-year-old and injured 16 others at Tuskegee University in Alabama. One student reported that she heard more than 100 rounds of gunshots and said the scene felt like a “war zone.”⁶⁸

140. Given the national attention following these shootings and resulting responses from federal, state, and local governments, Glock knew or should have known about mass shootings perpetrated with Glock switch-converted Glock handguns and the resulting deaths and injuries.

3. There Has Been Widespread Reporting That Glock Handguns Equipped with Switches Are Increasingly Being Used in Crimes.

141. Media and policy reports have highlighted the use of Glock handguns in crime—including Glock handguns converted into fully automatic machine guns with Glock switches.

⁶⁶ Michelle Watson, et al., *Up to \$100,000 In Rewards Offered for Tips to Solve Birmingham Shooting That Left 4 People Dead*, CNN (Sept. 23, 2024), <https://www.cnn.com/2024/09/23/us/birmingham-shooting-what-we-know/index.html>.

⁶⁷ Exec. Order No. 14127, 2 C.F.R. § 3 (2024).

⁶⁸ Toriano Porter, *My daughter ran for her life during Tuskegee University mass shooting. And I'm not OK*, The Kansas City Star (Nov. 15, 2024), <https://www.kansascity.com/opinion/opn-columns-blogs/toriano-porter/article295526079.html>.

142. A March 2022 VICE News article surveyed over 260 federal cases that were filed between 2017 and 2021, including robberies, assaults, and murders, that involved the use of converted, fully automatic Glock handguns. The survey found that, in 2017, there were only 10 such cases, but by 2019, that had risen to 82, and in 2021 there were 83 cases filed that involved the use of Glock handguns with Glock switches.⁶⁹

143. VICE also reported that ATF had “seized 1,500 weapons modified with auto sears in 2021, a staggering increase over 2020, when only 300 were recovered.” In total, from 2020 to 2022, “Homeland Security had seized 4,348 auto sears and opened up over 600 investigations related to the devices.”⁷⁰

144. In January 2023, ATF released a report on crime guns recovered and traced by law enforcement in the United States and its territories between 2017 and 2021. ATF’s report found Glock was the leading manufacturer of handguns used in crimes across the country: “Of the 1,306,804 pistol type crime guns traced between 2017 and 2021, nearly 20% (255,055) were manufactured by Glock.”⁷¹

145. Although Glock handguns represented about one in five of all handguns recovered by law enforcement nationally, Glock handguns accounted for *nine in ten* illegally converted machine guns in Chicago. An October 2022 NPR article reported that, in Chicago, police recovered 355 auto sear-equipped handguns in 2021 (up from zero in 2018) and that more than 90% of these

⁶⁹ Alain Stephens & Keegan Hamilton, *Tiny ‘Glock Switches’ Have Quietly Flooded the US With Deadly Machine Guns*, Vice (Mar. 24, 2022), <https://www.vice.com/en/article/glock-switches-auto-sears/>.

⁷⁰ *Id.*

⁷¹ Bureau of Alcohol, Tobacco, Firearms and Explosives, *Crime Guns Recovered and Traced Within the United States and Its Territories, Part III: Crime Guns Recovered and Traced Within the United States and Its Territories*, ATF, <https://www.atf.gov/firearms/docs/report/nfcta-volume-ii-part-iii-crime-guns-recovered-and-traced-us/download> (last visited Dec. 11, 2024).

were Glock handguns: “[a]t least 643 of the 706 modified weapons recovered by the Chicago police between 2018 and last month were Glock handguns.”

146. Glock handguns are attractive for criminal purposes because of their ease of conversion to fully automatic weapons. Thomas Chittum, former ATF Associate Deputy Director explained, “[i]t’s not enthusiasts who want to have a machine gun but can’t afford a legal one. It’s criminals who want as much firepower as they can get, and that’s part of the danger.”⁷²

147. Gang members have been known to use switch-equipped Glock handguns because they deliver a fully automatic spray of bullets at their intended targets.⁷³

148. The proliferation of Glock switches has reached Minnesota. A Minneapolis police officer testified that “it’s a status issue to be able to have a fully automatic handgun on the street” during the trial of an individual charged with possessing a Glock handgun with a switch.⁷⁴ Likewise, court documents from multiple criminal cases show defendants bragging about their Glock switches.⁷⁵

149. Given the reporting on the rampant use of Glock handguns equipped with Glock switches, Glock knew or should have known that its handguns have been illegally converted into machine guns and used to carry out numerous crimes.

⁷² Stephen Montemayor, *Modern-day Machine Guns*, Star Tribune (Oct. 18, 2023), <https://www2.startribune.com/guns-switches-turning-more-firearms-into-automatic/600312536/>.

⁷³ Alain Stephens & Keegan Hamilton, *Tiny ‘Glock Switches’ Have Quietly Flooded the US With Deadly Machine Guns*, Vice (Mar. 24, 2022), <https://www.vice.com/en/article/glock-switches-auto-sears/>.

⁷⁴ Tr. of Jury Trial, *United States v. Scott*, No. 22-cr-00136 (D. Minn. July 21, 2023), ECF No. 90 at 25.

⁷⁵ See *State v. Carroll*, No. A23-0399 (Minn. Ct. App. 2024); Tr. of July Trial, *United States v. Scott*, No. 22-cr-00136 (D. Minn. July 21, 2023), ECF No. 90 at 25; Government’s Sentencing Mem., *United States v. Armstrong*, No. 21-cr-00228 (D. Minn. May 24, 2023), ECF No. 144.

150. In addition, when a crime gun is traced, ATF “starts by contacting the manufacturer to begin to follow the gun’s path through the supply chain.”⁷⁶ Glock is alerted each and every time that a Glock firearm is recovered at a crime scene and traced by law enforcement.

C. Glock Made Material Omissions About Its Handguns.

151. At all times relevant to this Complaint, Glock had a duty to disclose material facts about the illegality of machine guns and the unavailability of its fully automatic handguns to the public in connection with its marketing and sale of semi-automatic handguns. Special circumstances exist that triggered a duty by Glock to disclose such material facts.

152. First, Glock had special knowledge unavailable to the Minnesota public when Glock marketed and promoted the desirability of fully automatic handguns and the ease of customizing Glock handguns. As the designer and manufacturer, Glock had special knowledge that its semi-automatic handguns could be converted into illegal, fully automatic machine guns—and that it was easy to do so. Glock was uniquely aware of the fact that its fully automatic handguns could not be sold to the public because they are machine guns that are generally illegal for those not in law enforcement or the military to possess. Glock nonetheless advertised the “fun” of fully automatic gunfire to the public and omitted material facts about the illegality of machine guns from its representations about its handguns.

153. Second, the nature and quality of the representations that Glock made to the public glorifying Glock fully automatic handguns were so incomplete regarding the illegality of automatic weapons as to be confusing, deceptive, and misleading.

⁷⁶ Brian Freskos, *How a Gun Trace Works*, Trace (July 8, 2016), <https://www.thetrace.org/2016/07/how-a-gun-trace-works-atf-ffl/>; see also Eric Flack, *Former ATF agent: Current gun tracing system is ‘insane,’* WUSA9 (May 1, 2018), <https://www.wusa9.com/article/news/investigations/former-atf-agent-current-gun-tracing-system-is-insane/65-547682302>.

154. Glock failed to tell the public that gun buyers were not allowed to purchase, possess, or use the fully automatic weapons Glock advertised, including under Minnesota law, while simultaneously advertising its automatic weapons to a civilian audience and promoting the ease of customizing its semi-automatic handguns by accessing internal parts and systems and attaching accessories.

155. Glock also failed to consistently tell the public that the use of Glock switches with its Glock handguns was illegal, including under Minnesota law.

III. Glock Handguns Equipped with Switches Are Proliferating and Causing Harm Across the Nation and in Minnesota.

A. Gun Violence Is a Public Health Crisis and the Number One Cause of Death of Children in the United States.

156. On June 14, 2016, the American Medical Association (AMA) adopted a policy calling gun violence in the United States “a public health crisis” requiring a comprehensive public health response and solution.⁷⁷

157. On June 25, 2024, United States Surgeon General Dr. Vivek Murthy issued a Surgeon General’s Advisory on Firearm Violence, declaring firearm violence in America to be a public health crisis.⁷⁸ The Surgeon General’s Advisory recognized that firearms are the leading cause of death for children and adolescents.

⁷⁷ Press Release, Am. Med. Ass’n AMA Calls Gun Violence “a Public Health Crisis” (June 14, 2016), <https://www.ama-assn.org/press-center/press-releases/ama-calls-gun-violence-public-health-crisis>.

⁷⁸ U.S. Dep’t Health and Hum. Servs., Office of the Surgeon General, *Firearm Violence in America* (July 18, 2024), <https://www.hhs.gov/surgeongeneral/priorities/firearm-violence/index.html>.

158. In 2020, guns surpassed motor vehicles as the number one cause of death for children ages 1-18.⁷⁹

B. Machine Gun Fire from Glock Handguns Equipped with Glock Switches Is Growing Rapidly and Exacerbating the Gun Violence Crisis in Minnesota.

159. The proliferation of Glock handguns equipped with switches has put communities in the Twin Cities and Greater Minnesota at greater risk of deadly harm from machine gun fire.

160. In federal court filings, federal prosecutors describe the Glock handgun equipped with a switch as “an incredibly dangerous weapon, whose sole purpose is to fire as many bullets in as rapid a period of time as possible. Instances of automatic or machinegun fire are becoming more and more common in neighborhoods in Minneapolis and St. Paul.”⁸⁰

161. The result is a dangerous new reality that Minnesota communities must now live with; even though the number of firearm shootings has decreased, the number of bullets being fired has risen dramatically, putting more bystanders in harm’s way.⁸¹

162. Law enforcement officials in Minnesota attribute the increase in gunfire to “the proliferation of illegal switches” for Glock handguns.⁸² The predominant firearms involved in recent federal prosecutions of machine gun crimes in Minnesota are Glock handguns equipped with switches. One ATF enforcement officer even testified in a 2023 prosecution in Minnesota

⁷⁹ Robert Gebeloff, et al., *Childhood’s Greatest Danger: The Data on Kids and Gun Violence*, N.Y. Times (Dec. 14, 2022), <https://www.nytimes.com/interactive/2022/12/14/magazine/gun-violence-children-data-statistics.html>.

⁸⁰ Government’s Sentencing Mem., *United States v. Tanner*, No. 22-cr-00019 (D. Minn. Aug. 27, 2022), ECF No. 44.

⁸¹ Chris Hrapsky, *Glock switch creator would ‘rather invent any other thing’ in wake of unintended consequences*, KARE11 (Feb. 11, 2024), <https://www.kare11.com/article/news/local/kare11-extras/dangers-of-the-controversial-glock-switch-as-told-by-its-inventor/89-9fd2745b-4616-4f8e-b993-3a7249d10f85#:~:> (“According to the Minneapolis Police Department, while overall shootings have gone down over the last two years, automatic gunfire continues to increase”).

⁸² *Id.*

that in the previous two years, he had performed more than 100 evaluations of Glock handguns equipped with Glock switches for ATF investigations and firearms prosecutions.⁸³

163. From January 1, 2018, through June 15, 2024, federal prosecutors in Minnesota initiated 52 prosecutions for violations of the federal prohibition against possession and transfer of a machine gun. The majority of these prosecutions were filed between January 2021 and the present; nearly all of the prosecutions involve Glock handguns equipped with switches.

164. Glock handguns equipped with switches are also often equipped with devices that increase their capacity for ammunition. Because these machine guns can fire an entire magazine with one trigger pull, the combination of Glock switches and high-capacity magazines increases the danger these weapons pose. In fact, in nearly all of the federal firearms prosecutions in Minnesota involving illegal possession of a Glock handgun equipped with a switch, the firearm was also equipped with high-capacity or extended magazines that can hold as many as 50 rounds.

165. Because machine guns are generally prohibited, fully automatic gunfire in Minneapolis was, until recently, relatively rare. This has now changed.

166. The City of Minneapolis employs a shot-detection technology known as ShotSpotter that detects incidents of gunfire and prompts law enforcement to respond to shootings across the city. In 2020, the city's ShotSpotter network detected just 16 fully automatic firearm incidents with 154 shots fired. In 2021, ShotSpotter detected 194 fully automatic firearm incidents with 2,033 shots fired—a greater than 1100% increase. In 2022, ShotSpotter detected 283 incidents with 3,024 shots fired. In 2023, ShotSpotter detected 257 incidents with 2,595 shots fired.

⁸³ Trial Test. of Officer Adam Evans, *United States v. Armstrong*, No. 21-cr-00228 (D. Minn. Mar. 13, 2023), ECF No. 120.

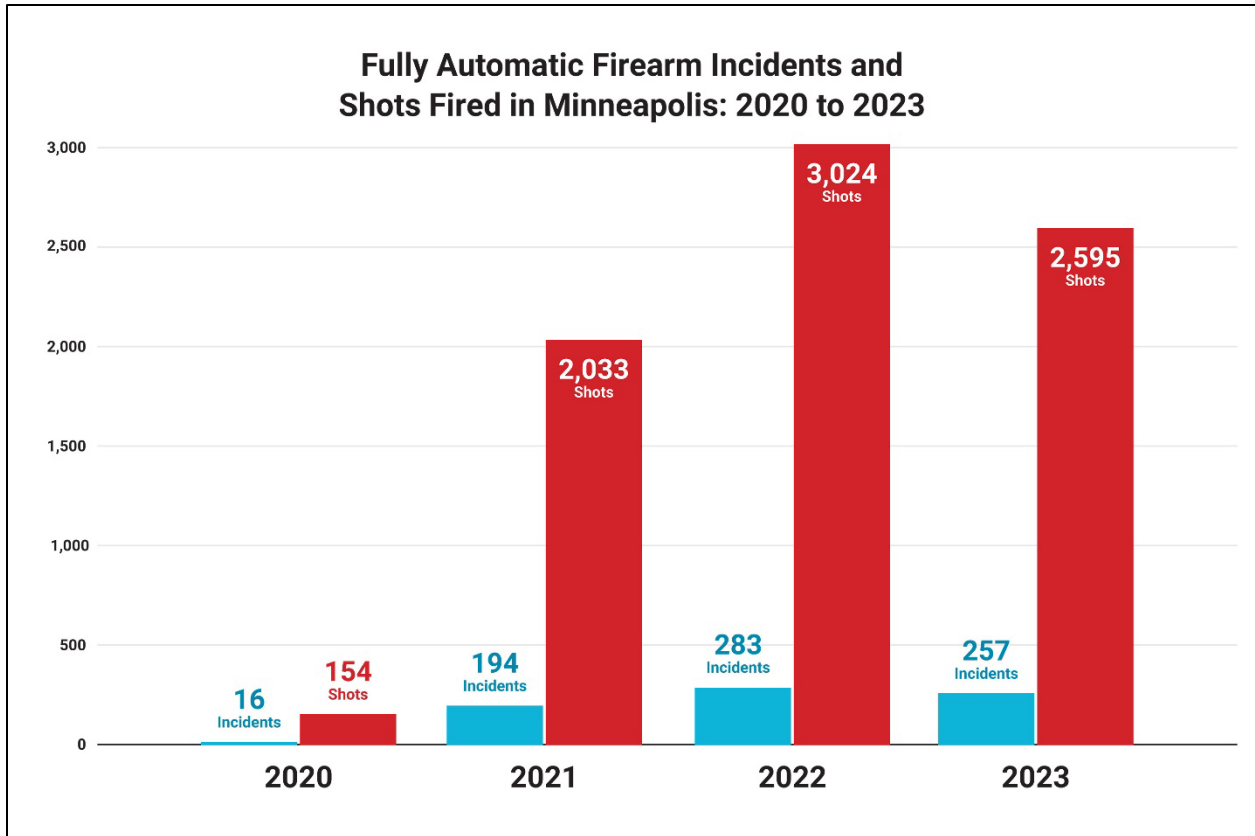

167. A gun violence report for the City of Minneapolis from 2022 shows that gun violence between January 2019 and August 2022 increased as follows⁸⁴:

- The number of homicides was up 166% (21 vs. 56)
- The number of gunshot victims was up 101% (176 vs. 354)
- The number of shooting-related phone calls was up 133% (2,494 vs. 5,810)
- The number of firearm rounds detected was up 230% (3,888 vs. 12,849)
- The number of discharged cartridge casings recovered from crime scenes was up 263% (1,796 vs. 6,523).

⁸⁴ Jason Case, Austin Rice & Thomas Bacon, *Minneapolis Police Department 2022 Gun Violence Overview Presentation* (Aug. 8, 2022), <https://lms.minneapolismn.gov/Download/RCAV2/28255/PHS-8-9-22---Gun-Violence-Overview.pdf>

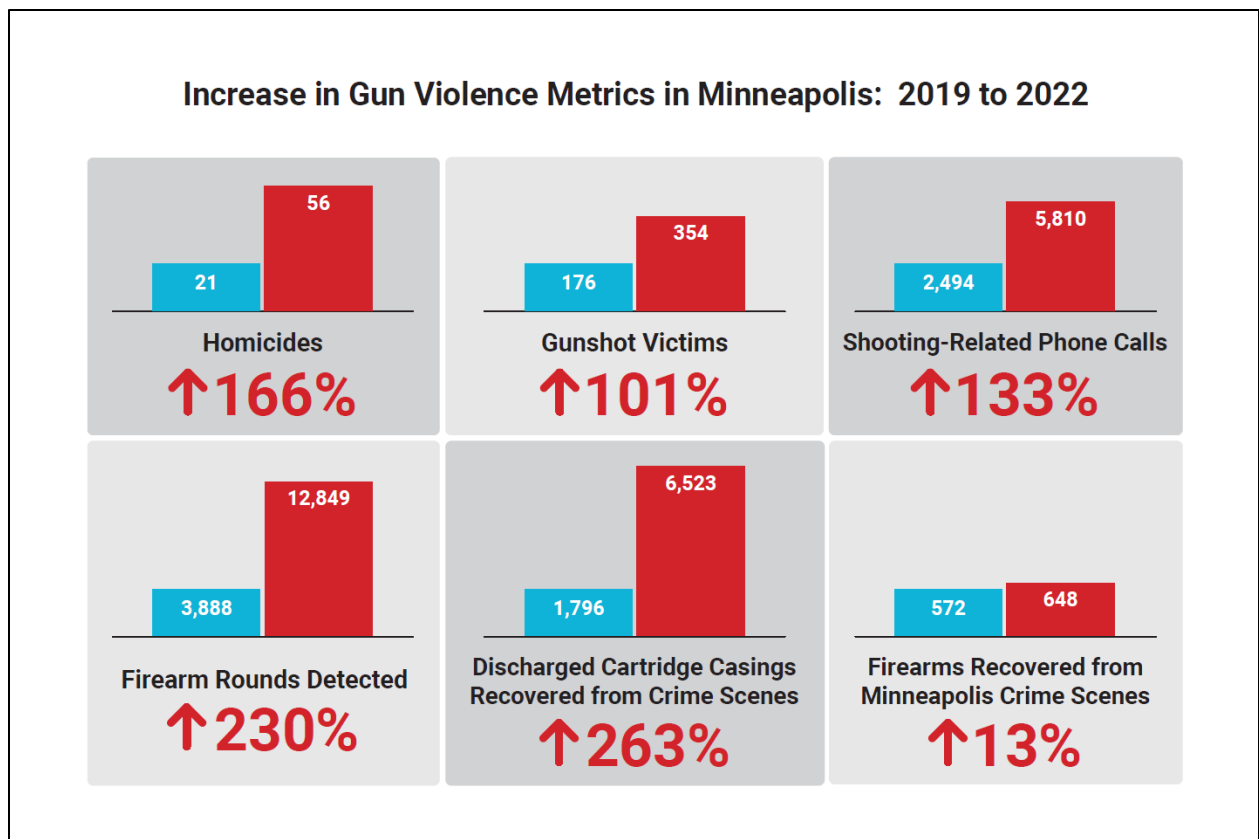

168. During the same period, firearms recovered from Minneapolis crime scenes increased just 13%, from 572 to 648, showing that the root cause of the surge in gun violence cannot be attributed solely to a greater volume of guns on the street.

169. In 2023, the Minneapolis Police Department recovered three times as many Glock switches than they recovered in 2021, when the department first started tracking the devices.⁸⁵

170. Handgun-related deaths have spiked across Minnesota in recent years. Between 2015 and 2021, the number of homicides committed with a firearm more than doubled from 48 to 102.⁸⁶ At the same time, the proportion of firearm homicides that were committed with a handgun

⁸⁵ Stephen Montemayor, *Modern-day Machine Guns*, Star Tribune (Oct. 18, 2023), <https://www2.startribune.com/guns-switches-turning-more-firearms-into-automatic/600312536/>.

⁸⁶ *Minnesota Violent Death Reporting System (MNVDRS) Dashboard*, Minn. Dep’t Health (last updated June 3, 2024), <https://www.health.state.mn.us/communities/injury/midas/mnvdrs.html>.

increased from 57.1% to 67.5%. The year 2021 saw a record number of homicides for the city of St. Paul, and the most homicides in Minneapolis since 1995.⁸⁷

171. Shootings that involve Glock handguns equipped with switches in Minnesota result in more victims and more injuries. Hennepin County paramedics have observed an increase in the number of gunshot victims with multiple wounds—a factor that makes treatment more complicated and lowers the chance that a victim will survive.⁸⁸

172. The Chief of Emergency Medicine at Hennepin County Medical Center (Minnesota’s largest emergency department and busiest trauma center), Dr. James Miner, has recognized the same pattern. Dr. Miner has explained that “he first heard about switches in 2020 when he was trying to make sense of why gunshot victims were arriving at the hospital with numerous wounds and why more people seemed to be reporting being shot by stray bullets.”⁸⁹

C. Glock Handguns Equipped with Switches Have Harmed Minnesotans.

173. Behind the alarming data cited above are people whose lives have been forever changed by the violence inflicted with fully automatic Glock handguns. As a result of Glock’s handgun design and marketing and refusal to change the design, Minnesotans have lost family and friends and suffered life changing injuries.

⁸⁷ Andy Mannix & Jeff Hargarten, *Minneapolis Closes in on Homicide Milestone at End of Violent Year*, Star Tribune (Dec. 20, 2021), <https://www.startribune.com/a-most-violent-year-in-minneapolis/600131444>.

⁸⁸ Libor Jany, *Illegal Gun Modification Devices Proliferate, Resulting in More Deadly Rounds in Minneapolis*, Star Tribune (Oct. 13, 2021), <https://www.startribune.com/illegal-gun-modification-devices-proliferate-resulting-in-more-deadly-rounds-in-minneapolis/600106352>.

⁸⁹ Ernesto Londoño & Glenn Thrush, *Inexpensive Add-on Spawns a New Era of Machine Guns*, N.Y. Times (Aug. 12, 2023), <https://www.nytimes.com/2023/08/12/us/guns-switch-devices.html>.

1. On May 22, 2021, a Glock Equipped with a Switch Was Used in a Shootout Outside a Minneapolis Nightclub Where Two People Died and Seven People Were Wounded.

174. In the early hours of May 22, 2021, gunfire erupted on the crowded sidewalks outside the Monarch nightclub in the North Loop neighborhood of Minneapolis. Surveillance videos showed that Jawan C. Carroll shot and killed his intended victim, C.R.J., after a friend of Carroll's punched C.R.J. Carroll has a long history of gang and gun-related violence.⁹⁰

175. The other person killed, C.B.J., was a bystander and a senior at a local college, who was hit in the back by a stray bullet as he fled. C.B.J. was celebrating hours before his college graduation ceremony. He died at the scene.

176. The violence arose from a confrontation between groups associated with Carroll and C.R.J. The groups were flaunting their Glock handguns and threatening each other. C.R.J. approached Carroll's group and asked, "What you all doing down here?" Someone responded, "We can go anywhere we want." C.R.J. stated, "You know there's switches on these mother-fckers" and flashed his gun, bragging, "You know I got the Glock 19 with a switch on it." Then someone responded, "We got them b-tches too." One of Carroll's friends punched C.R.J. Within seconds, gunfire erupted. C.R.J.'s Glock handgun equipped with a switch also had an extended magazine that increased its capacity to 32 rounds.⁹¹

177. In addition to C.B.J., seven other victims were wounded at the scene, but survived.

⁹⁰ Kim Hyatt, *Man Sentenced to 69 Years for Mass Shooting in Downtown Minneapolis that Killed 2, Hurt 7*, Star Tribune (Dec. 16, 2022), <https://www.startribune.com/69-years-in-prison-for-man-convicted-of-murder-in-mass-shooting-outside-minneapolis-nightclub/600236536>.

⁹¹ See *State v. Carroll*, No. A23-0399, 2024 WL 1714227 (Minn. Ct. App. Apr. 22, 2024).

2. On July 26, 2022, a Glock Handgun Equipped with a Switch Was Used in a Shooting Outside a Minneapolis Police Station.

178. On July 26, 2022, at about 12:30 a.m. automatic gunfire erupted outside the Minneapolis 4th Precinct. Several officers who were standing outside the precinct or sitting in their squad cars in the parking lot behind the station and saw and heard the automatic gunfire, which hit the police station and surrounding homes.

179. The officers witnessed the shooter, Davion Gaines, get into a Ford Taurus and flee the scene. The officers pursued the Taurus in their squad cars around the block. The Taurus stopped in an alley. Gaines got out and ran to another sedan parked nearby, disappeared for a moment, and then reappeared with both of his hands above his head. Gaines and two accomplices were arrested. At the time of the arrest, officers found a Glock handgun equipped with a switch and an extended magazine in front of the sedan Gaines had been hiding behind. Gaines was charged with possession and operation of a machine gun.⁹²

3. On July 28, 2022, a Glock Handgun Equipped with a Switch Killed One Man and Injured Two Other People in Minneapolis in Seconds.

180. On July 28, 2022, a 20-year-old was killed and two other people were wounded when a gunman unleashed “a barrage of rounds” from a fully automatic switch-equipped Glock outside of a Minneapolis bar.⁹³

181. The shooting erupted as bar patrons went into a crowded parking lot. One of the victims died after being shot seven times in the back and neck in just seconds. Two other victims were each shot five times as they ran away from the gunfire aimed at the deceased victim.

⁹² Compl., *State v. Gaines*, 27-CR-22-14688 (Hennepin Cnty. Dist. Ct. July 27, 2022); *see also* Compl., *State v. Thompson*, 27-CR-22-14687 (Hennepin Cnty. Dist. Ct. July 27, 2022); Compl., *State v. Teasley*, 27-CR-22-14686 (Hennepin Cnty. Dist. Ct. July 27, 2022).

⁹³ Compl. at 4, *State v. Longmire*, 27-CR-22-19737 (Hennepin Cnty. Dist. Ct. Oct. 3, 2022).

182. Forensic testing later established that a switch-equipped .40-caliber Glock had fired the twenty-one .40-caliber casings present at the scene.

4. On September 17, 2022, a Glock Handgun Equipped with a Switch Was Used to Shoot a Man Outside a Minneapolis Night Club.

183. On September 17, 2022, a man was shot multiple times in the chest, back, and leg outside a Minneapolis night club with a Glock handgun equipped with a switch. A police officer responding to the scene was parked at a nearby intersection and reported hearing fully automatic gunfire.⁹⁴ Nine shell casings were found at the scene.

184. The shooting was captured on surveillance video. According to court records, the video showed defendant Demetrius Ramsey approach the victim from behind, shoot the victim “at close range, with the firearm nearly touching the victim,”⁹⁵ before concealing the gun and fleeing the scene.

185. Ramsey was eventually arrested in possession of a Glock handgun equipped with a Glock switch and a loaded extended magazine. According to the criminal complaint, Ramsey confirmed, on questioning, that he used the Glock equipped with a switch to shoot the victim and did not deny shooting the victim.

5. On December 14, 2022, a “Pro Mass Shooting” Neo-Nazi Sympathizer Was Arrested After Plotting to Commit Acts of Violence Against Law Enforcement with a Glock 17 Handgun Equipped with a Switch.

186. On December 14, 2022, twenty-year-old William River Smith was arrested for illegal possession of a machine gun after he purchased a Glock switch and other auto sear devices

⁹⁴ Compl., *State v. Ramsey*, 27-CR-22-18991 (Hennepin Cnty. Dist. Ct. Sept. 23, 2022); *State v. Ramsey*, A23-1554 (Minn. App. Oct. 28, 2024) (slip op.).

⁹⁵ Compl., *State v. Ramsey*, 27-CR-22-18991 (Hennepin Cnty. Dist. Ct. Sept. 23, 2022).

from an FBI informant in order to convert his guns into fully automatic machine guns.⁹⁶ At the time of his arrest, Smith had a loaded Glock 17 with three full magazines for a total of 52 rounds of ammunition. There were an additional 900 rounds of ammunition loaded into eleven magazines in his car.

187. Smith had contacted the informant specifically to inquire about purchasing a Glock switch and other auto sear devices to convert his Glock handgun and his AR-15 style rifle into fully automatic machine guns.

188. Before purchasing the Glock switch, Smith described in a text message a “good dream” he had, which involved throwing a hand grenade into a room full of police officers before shooting anyone left alive with a fully automatic Glock 18 handgun. He said that in his dream, he walked “from cop to cop shooting them with the G18”—i.e., the fully automatic Glock 18 handgun.⁹⁷

189. Smith told an informant that he plotted to use his converted fully automatic Glock 17 to attack Minneapolis police officers.

190. He also told the informant, “I want full auto just cause it’s fun too.”⁹⁸

6. On December 18, 2022, a Glock Equipped with a Switch Was Used in a Shooting Near the Children’s Hospital of Minnesota.

191. On December 18, 2022, Minneapolis police received a 911 call that reported shots fired from four people in a vehicle near the Children’s Hospital of Minnesota. Police located and

⁹⁶ Press Release, U.S. Attorney’s Office, Dist. Minn., *Savage Man Sentenced to More Than Six Years in Prison for Illegal Possession of a Machine Gun and Attempted Possession of Grenades*, (Jan. 30, 2024), <https://www.justice.gov/usao-mn/pr/savage-man-sentenced-more-six-years-prison-illegal-possession-machine-gun-and-attempted>.

⁹⁷ Government’s Position on Sentencing at 16, *United States v. Smith*, No. 23-cr-00007 (D. Minn. Nov. 21, 2023), ECF No. 87.

⁹⁸ *Id.* at 15.

stopped the suspect vehicle, and a search revealed a Glock 30 .45-caliber handgun equipped with a switch, a laser sight, and extended magazine underneath the rear seat occupied by alleged gang member Marvin Miller. Miller was charged in federal court with possession of a machine gun. It was his fourth conviction for possession of illegal firearms in the last 15 years.⁹⁹

7. On March 4, 2023, a Glock Handgun Equipped with a Switch Was Used to Kill a Victim at a Plymouth House Party.

192. On March 4, 2023, a Glock equipped with a switch was used by a teenager to kill another teenager at a house party in Plymouth. Raheim Cooper and A.B, the shooter and the victim, were at a birthday party. The two had an “ongoing dispute” on Snapchat. The two were seen arguing at the party when, at one point, Cooper punched A.B.

193. Cooper then pulled out a Glock handgun and shot A.B. three times—in his right groin, right hip, and right rib area. Cooper said that he was bumped or pushed from behind and that his switch-equipped Glock handgun fired several rounds.

194. When police arrived, A.B. was found in the kitchen and pronounced dead. Inside Cooper’s backpack was the loaded Glock handgun with a mounted laser and equipped with a switch that converted the Glock handgun into an illegal, fully automatic machine gun.¹⁰⁰

195. Cooper later admitted that the shooting was committed in a particularly serious way because the gun was equipped with a Glock switch—making it an illegal fully automatic machine gun—and that the gun was fired in a crowded party, risking death or great bodily harm to bystanders.

⁹⁹ Government’s Position on Sentencing, *United States v. Miller, Jr.*, No. 23-cr-00274 (D. Minn. filed May 28, 2024), ECF No. 52.

¹⁰⁰ David Griswold & Dana Thiede, *Man Sentenced in Deadly Shooting at Plymouth Party*, *Kare 11* (Dec. 4, 2024, 12:14 PM), <https://www.kare11.com/article/news/crime/man-sentenced-in-shooting-at-plymouth-party/89-d9bf54da-3f58-4bec-955c-7855f1630ccb>.

8. On August 11, 2023, a Glock Handgun Equipped with a Switch Was Used in an Ambush Shooting of a Minneapolis Police Officer.

196. On the evening of Friday, August 11, 2023, a Minneapolis police officer was on patrol when he received a call to be on the lookout for the vehicle of Fredrick Davis Jr., who was suspected of being tied to a robbery in Brooklyn Park. The officer spotted Davis Jr.'s vehicle and began following it and called for backup. Davis Jr. noticed that he was being followed, then told a passenger that "it's gonna happen right here."

197. At an intersection further down the street, the officer was suddenly ambushed by a barrage of gun fire coming from two directions. Twelve rounds were fired from a fully automatic Glock 19 equipped with a switch. The officer felt his arm go numb and accelerated away from the scene. Backup officers were able to meet him nearby, where they pulled him from the vehicle and took him to the hospital.

198. One bullet passed through the officer's arm and into his torso, narrowly missing a major artery, before lodging in his chest.¹⁰¹

199. Davis Jr. fled the scene, but crashed his vehicle, fled on foot, and was eventually apprehended. Officers discovered a Glock handgun in Davis Jr.'s vehicle with an extended magazine that allowed it to hold additional ammunition.

¹⁰¹ Liz Sawyer, *ATF: Firearm That Wounded Minneapolis Police Officer Linked to Other Twin Cities Shootings*, Star Tribune (Aug. 30, 2023, 5:18 PM), <https://www.startribune.com/atf-firearm-wounded-minneapolis-police-officer-linked-to-five-other-twin-cities-shootings-summer/600300952>.

9. On June 8, 2024, Three Glock Handguns Equipped with a Switch Were Recovered from Suspects of a Shooting at a Brooklyn Park Bar.

200. On June 8, 2024, 19-year-old Raquan Rahjai Johnson was caught by Brooklyn Park police with a Glock handgun equipped with a switch after he was apprehended during a traffic stop with a person who was a suspected accomplice to a recent shooting at a Brooklyn Park bar.

201. During the stop, another Glock handgun equipped with a switch was recovered from the accomplice as he fled the police on foot. The occupants in the car were searched, and yet another Glock handgun equipped with a switch was recovered.

202. This was not Johnson's first time caught with a Glock handgun equipped with a switch—in fact, a year earlier he had been found in possession of a virtually identical Glock and switch during an arrest in 2023.¹⁰²

D. Numerous Glock Handguns Equipped with Switches Have Been Recovered in Minnesota.

203. In addition to the mass shootings and other incidents in Minnesota involving Glock handguns equipped with switches described above, numerous Glock handguns equipped with switches have been recovered in Minnesota.

204. Marques Armstrong Jr. was arrested in October 2021 after fleeing the police. While he was fleeing, he discarded a bag holding a Glock handgun equipped with a switch and a high-

¹⁰² Stephen Montemayor, *Federal Charges: Shooting Suspect Caught in Brooklyn Park with Similar Switch-Enabled Gun He Had in 2023 Drug Arrest*, Star Tribune (June 22, 2024, 6:34 PM), <https://www.startribune.com/federal-charges-shooting-suspect-caught-in-brooklyn-park-with-same-switch-enabled-gun-he-had-in-2023-drug-arrest/600375172>.

capacity magazine. Before this arrest, Armstrong had served four years in federal prison for his role in purchasing and sharing guns traced to multiple crimes in Minnesota.¹⁰³

205. In January 2022, two teenage twin brothers were arrested in Minneapolis and charged with possessing handguns “illegally altered to fire automatically” after leaving the funeral of a friend who had been shot to death in a “robbery-gone-wrong.”¹⁰⁴ The pair were found with three Glock handguns equipped with Glock switches.

206. In June 2022, Minneapolis police received a complaint that Derrick Maurice Scott had threatened another man while brandishing a firearm at a convenience store. Two days later, Scott was found in possession of a Glock 41 equipped with a Glock switch, along with a high-capacity magazine and 14 rounds of ammunition.¹⁰⁵

207. In May 2022, Markyse Maurice Wells was charged in Minnesota federal court for possession of a machine gun after officers found a Glock handgun equipped with a Glock switch and an extended magazine inside Wells’ vehicle. Wells has prior felony convictions and is not allowed to possess a firearm.¹⁰⁶

¹⁰³ Stephen Montemayor, *Firearm Tracing Hampered by Law*, Star Tribune (Aug. 25, 2023), <https://www2.startribune.com/minnesota-police-recovering-record-number-guns-tracing-crimes-backlog/600299434/>; see also Government’s Sentencing Mem., *United States v. Armstrong*, No. 21-cr-00228 (D. Minn. May 24, 2023), ECF No. 144.

¹⁰⁴ Libor Jany, *Teens Leaving Friend’s Funeral Charged with Possession of ‘Auto-Sear’-Enhanced Guns in Minneapolis*, Star Tribune (Jan. 19, 2022, 4:52 PM), <https://www.startribune.com/teens-leaving-friends-funeral-charged-with-possession-of-auto-sear-enhanced-guns-in-minneapolis/600137494>.

¹⁰⁵ Stephen Montemayor, *He Scoffed at Gun, Fentanyl Arrest. Now He Will Get 30 Years*, Star Tribune (Feb. 8, 2023, 7:45 PM), <https://www.startribune.com/maple-grove-man-faces-mandatory-30-year-sentence-for-federal-gun-drug-convictions/600250065>.

¹⁰⁶ Press Release, U.S. Attorney’s Office, Dist. Minn., *Brooklyn Park Felon Indicted for Possessing a Firearm, Glock Switch* (May 26, 2022), <https://www.justice.gov/usao-mn/pr/brooklyn-park-felon-indicted-possessing-firearm-glock-switch>.

208. In August 2022, Gerald Darius Smith was arrested on an outstanding warrant and found with a Glock .40-caliber handgun equipped with a switch in his backpack in St. Paul. Smith had been wanted for “an alarming sequence of crimes,” including aggravated robbery, burglary, high-speed police chases, and several incidents involving unlawful firearm possession, including a Glock 17 with an extended magazine.¹⁰⁷

209. In February 2023, St. Paul police responded to a report that a group of people in a vehicle were chasing and shooting at the occupants of another vehicle with an automatic weapon. The police apprehended 19-year-old Moesha Isiah Hart and, in the driver’s side door of his vehicle, found a loaded Glock 45 9mm handgun equipped with a Glock switch and a high-capacity magazine. Eleven bullet casings were located in and around the driver’s area of the vehicle, which was stolen in St. Paul in December 2022.¹⁰⁸

210. In April 2023, law enforcement arrested a prominent member of a Minneapolis street gang, Montez Brown, and indicted him on federal RICO charges. When Brown was arrested, law enforcement seized a large volume of illegal narcotics and two firearms, including a Glock handgun equipped with a Glock switch and an extended magazine.¹⁰⁹

211. In May 2023, Richfield resident Vatthana Andy Sengsouriya pled guilty to possessing a firearm equipped with a Glock switch. The charges arose from an attempt to arrest

¹⁰⁷ Government’s Position on Sentencing, *United States v. Smith*, No. 22-cr-00361 (D. Minn. Aug. 28, 2023), ECF No. 53.

¹⁰⁸ Kristi Miller, *St. Paul Man, 19, Pleads Guilty to Federal Gun Charge in 2023 Shootout, Pursuit and Restaurant Crash*, Pioneer Press (Mar. 30, 2024), <https://www.twincities.com/2024/03/29/st-paul-man-19-pleads-guilty-to-federal-gun-charge-in-2023-shootout-pursuit-and-restaurant-crash/>.

¹⁰⁹ Stephen Montemayor, *Member of Highs Gang Given Nearly 20-Year Sentence in Federal Racketeering Case*, Star Tribune (Apr. 10, 2024, 6:50 PM), <https://www.startribune.com/member-of-highs-gang-given-nearly-20-year-sentence-in-federal-racketeering-case/600357925>.

Sengsouriya in October 2022 in a Home Depot parking lot on outstanding charges. Sengsouriya fled in his vehicle and then on foot. When he was apprehended, police found 115 grams of cocaine and a Glock handgun with a Glock switch.

212. In August 2023, in connection with a sprawling RICO case against street gangs being prosecuted in Minnesota federal court, Marquez Demar Hill-Turnipseed was charged with possession of a machine gun after he was found with a Glock 30 handgun equipped with a switch in his laundry hamper.¹¹⁰

213. In October 2023, the Ramsey County Sheriff's Office raided a house party at a rental property in Maple Grove as part of an investigation of stolen credit cards. The suspect was celebrating his 17th birthday, and the party had about 50 guests ranging from 15 to 21 years old. When sheriff's deputies searched the home, they found 11 handguns. Seven of the handguns discovered in the house were Glock handguns equipped with switches.¹¹¹

214. In December 2023, Rochester police arrested and charged Robert Alvin Cleaves with possession of a machine gun. During a traffic stop, officers spotted a 9mm bullet in Cleaves' glove compartment. Cleaves then sped away, later crashing into a tree. Officers discovered a Glock 19 handgun equipped with a Glock switch and a 30-round magazine on the floor of the vehicle.¹¹²

¹¹⁰ Affidavit of Nicholas Bradt, *United States v. Hill-Turnipseed*, No. 23-CR-00246 (D. Minn. June 30, 2023), ECF No. 2-1.

¹¹¹ Mara H. Gottfried, *Maple Grove 'Airbnb Become Machine GunBNB,' Sheriff's Office Says After 11 Guns Found at Teen's Birthday Party*, Pioneer Press (Oct. 23, 2023, 6:10 PM), <https://www.twincities.com/2023/10/23/maple-grove-airbnb-guns-found-birthday-party/>.

¹¹² Andy Brownell, *Rochester Man Convicted of Possessing Machine Gun & Other Charges*, KROC News (Sept. 10, 2024), <https://krocnews.com/rochester-man-convicted-of-possessing-machine-gun-other-charges/>.

215. Because of Glock’s misconduct, the Minnesota Attorney General brings the following claims to hold Glock accountable and protect Minnesotans.

COUNT I
Public Nuisance
(All Defendants)

216. The State re-alleges all prior paragraphs of this Complaint.

217. Minnesota Statutes section 609.74 provides, in part:

Whoever by an act or failure to perform a legal duty intentionally does any of the following is guilty of maintaining a public nuisance, which is a misdemeanor:

(1) maintains or permits a condition which unreasonably annoys, injures or endangers the safety, health, morals, comfort, or repose of any considerable number of members of the public; or

(3) is guilty of any other act or omission declared by law to be a public nuisance and for which no sentence is specifically provided.

218. Minnesota and its residents have a public right to be free from interference with public safety, health, comfort, or repose. The State is empowered by equity and law, including Minn. Stat. § 8.31, to allege a claim, and seek redress for, a public nuisance. The State, in its capacity as a public litigant and as *parens patriae*, as well as a payor of public monies for costs incurred through its provision of governmental programs and services, has an important and unique interest in protecting health and safety.

219. Through the illegal, unfair, unconscionable, deceptive, and fraudulent conduct described throughout this Complaint, Glock has intentionally maintained or permitted, or was a substantial factor in maintaining or permitting, a public nuisance that has annoyed, injured, and endangered—and continues to unreasonably annoy, injure, and endanger—the common right of public health, comfort, or repose of considerable members of the public.

220. Glock, in the course of manufacturing, marketing, distributing, and selling firearms, has foreseeably created a public nuisance by unreasonably interfering with rights common to the general public as prohibited by Minnesota law. Glock's acts and practices that unreasonably interfered with rights common to the general public include the following:

- a. Designing semi-automatic handguns in such a manner that they can be easily converted into illegal, fully automatic machine guns;
- b. Promoting the desirability of fully automatic Glock handguns, while knowing that it is illegal for civilians to purchase fully automatic weapons and knowing that the only way that civilians can possess Glock handguns with fully automatic capacity is for them to equip Glock handguns with Glock switches, thereby encouraging the conversion of Glock semi-automatic handguns into fully automatic machine guns;
- c. Promoting the ease of customizing Glock handguns by accessing internal parts and systems and attaching accessories based on their "simple" and "easy" design, thereby knowingly encouraging and facilitating the conversion of Glock semi-automatic handguns into fully automatic machine guns;
- d. Failing to acknowledge that Glock switches are illegal and dangerous when Glock features fully automatic Glock handguns in its advertising, and failing to denounce the use of Glock switches or warn the public that Glock switches are not Glock products; and
- e. Failing to correct the design of Glock semi-automatic handguns to prevent their simple or easy conversion into fully automatic machine guns.

221. Glock's conduct also includes knowingly violating and aiding and abetting the violation of Minnesota law, including Minnesota Statutes sections 325D.44, 325F.67, 325F.69, and 609.67.

222. Glock's conduct is widespread and persistent, and has created, is creating, and will likely continue to create substantial ongoing harm to Minnesota and its residents. As described above, Minnesotans face an epidemic of gun violence from automatic gunfire, including stark increases in the number of handgun-related deaths, injuries, and public shootings that involve fully automatic gunfire. The concomitant increase in prosecutions for machine gun possession and the recovery rate of Glock switches by law enforcement show that Glock handguns equipped with Glock switches have substantially contributed to this epidemic of fully automatic gunfire. As a result, the State has incurred and continues to incur substantial costs from investigating, monitoring, policing, and remediating harm from Glock handguns equipped with Glock switches.

223. Glock's conduct in maintaining or permitting a public nuisance has openly, publicly, repeatedly, continuously, persistently, and intentionally violated Minnesota law, as described throughout this Complaint. Glock's conduct is sufficiently pervasive that it cannot be adequately addressed or remedied by resort to criminal enforcement of Minnesota Statutes sections 609.67, 609.74, or other criminal statutes. Glock's widespread interference with public rights and privileges and endangerment of public safety requires the State to seek injunctive and all other appropriate equitable relief against Glock in order to abate this public nuisance and remedy the resultant harm, both retrospectively and prospectively.

224. Furthermore, pursuant to Minnesota Statutes section 325F.67, as pleaded below, Glock's dissemination of advertisements containing material assertions, representations,

omissions, or statements of fact that are untrue, deceptive, or misleading, as described throughout this Complaint, constitutes a public nuisance for which the State is entitled to equitable relief.

COUNT II
Aiding and Abetting Negligence Per Se
(All Defendants)

225. The State re-alleges all prior paragraphs of this Complaint.

226. Minnesota Statutes section 609.67, subdivision 2(a), provides as follows:

Except as otherwise provided herein, whoever owns, possesses, or operates a machine gun, or any trigger activator or machine gun conversion kit may be sentenced to imprisonment for not more than 20 years or to payment of a fine of not more than \$35,000, or both.

227. A “machine gun” is defined as “any firearm designed to discharge, or capable of discharging automatically more than once by a single function of the trigger.” Minn. Stat. § 609.67, subd. 1(a).

228. The meaning of “trigger activator” includes “a device that allows a semiautomatic firearm to shoot more than one shot with a single pull of the trigger or by harnessing the recoil of energy of the semiautomatic firearm to which it is affixed so that the trigger resets and continues firing without additional physical manipulation of the trigger.” Minn. Stat. § 609.67, subd. 1(d)(2).

229. A “machine gun conversion kit” is defined as “any part or combination of parts designed and intended for use in converting a weapon into a machine gun, and any combination of parts from which a machine gun can be assembled.” Minn. Stat. § 609.67, subd. 1(e).

230. A Glock switch is both a “trigger activator” and a “machine gun conversion kit,” and a Glock switch converts a Glock semi-automatic handgun into a “machine gun” within the meaning of this statute.

231. Under the law, Minnesotans owe a duty of care to their fellow citizens, particularly when it comes to firearm possession and use. This duty of care includes compliance with

Minnesota’s ban on the possession and use of machine guns and machine gun conversion devices, Minn. Stat. § 609.67.

232. Minnesota Statutes section 609.67 is intended to curb firearm crime and protect public safety by prohibiting the use and possession of uniquely dangerous fully automatic machine guns by the Minnesota public. This law imposes obligations and restrictions on the public to further its purpose.

233. The State and its residents are within the class of persons meant to be protected by Minn. Stat. § 609.67, and the injuries to the State and its citizens are of the nature that this statute was designed to prevent.

234. Accordingly, each time a Minnesotan possesses a Glock switch, or attaches a Glock switch to a Glock semi-automatic handgun and easily converts the Glock semi-automatic handgun into a fully automatic machine gun, they violate Minnesota Statutes section 609.67, which constitutes a breach of that person’s duty of care under section 609.67 and, therefore, is negligence per se.

235. People harmed by the violations of Minnesota Statutes section 609.67 from the possession and use of Glock handguns equipped with Glock switches are within the intended protection of the statute—i.e., people harmed by gun violence—and the harm suffered is of the type the statute was intended to prevent—i.e., gun violence.

236. Glock took affirmative acts with the intention that people would easily convert their semi-automatic Glock handguns into machine guns with Glock switches.

237. Glock’s affirmative acts include Glock’s “simple” semi-automatic handgun design and Glock’s promotion of customizing Glock semi-automatic handguns.

238. Glock's affirmative acts also include Glock's intentional promotion of fully automatic Glock handguns, including communicating that they are "fun" and desirable (e.g., "#GlockPorn"), even though such machine guns are illegal for ordinary consumers to possess.

239. Glock knew that individuals were easily equipping Glock handguns with Glock switches.

240. By refusing to change the design of Glock handguns despite knowledge that the handguns can easily be converted to illegal machine guns by equipping them with Glock switches, Glock substantially assisted individuals to violate Minnesota Statutes section 609.67 by converting Glock semi-automatic handguns to illegal machine guns with Glock switches.

241. By marketing the attractiveness and desirability of fully automatic Glock handguns to the public, Glock encouraged individuals to violate Minnesota Statutes section 609.67 by attaching Glock switches to Glock semi-automatic handguns.

242. Glock aided and abetted each and every violation of Minnesota Statutes section 609.67 that occurred when individuals attached Glock switches to Glock semi-automatic handguns, and thereby aided and abetted the tort of negligence per se.

243. As a direct and proximate result of Glock's conduct described herein, Minnesotans have suffered and will continue to suffer substantial harm.

244. Glock's conduct, practices, actions, and material omissions described in this Complaint constitute multiple instances of aiding and abetting the tort of negligence per se under Minnesota law.

COUNT III
Prevention of Consumer Fraud Act, Minnesota Statutes Section 325F.69
(All Defendants)

245. The State re-alleges all prior paragraphs of this Complaint.

246. The Prevention of Consumer Fraud Act (“CFA”) broadly prohibits fraudulent, deceptive, unfair, and unconscionable practices in connection with the sale of any merchandise, including handguns:

The act, use, or employment by any person of any fraud, unfair or unconscionable practice, false pretense, false promise, misrepresentation, misleading statement or deceptive practice, with the intent that others rely thereon in connection with the sale of any merchandise, whether or not any person has in fact been misled, deceived, or damaged thereby, is enjoined as provided in section 325F.70.

Minnesota Statutes section 325F.69, subd. 1.¹¹³

247. An “unfair or unconscionable act or practice” is further defined by Minnesota Statute section 325F.69, subd. 8, as “any method of competition, act, or practice that: (1) offends public policy as established by the statutes, rules, or common law of Minnesota; (2) is unethical, oppressive, or unscrupulous; or (3) is substantially injurious to consumers.”

248. The term “person” includes any partnership or corporation, foreign or domestic. Minn. Stat. § 325F.68, subd. 3. Both Glock defendants are “person[s]” within the meaning of this statute.

249. Glock’s semi-automatic and fully automatic handguns are “merchandise” within the meaning of this statute. Minn. Stat. § 325F.68, subd. 2.

250. Glock repeatedly violated the CFA by engaging in the fraudulent, deceptive, unfair, and unconscionable acts, practices, and omissions described in this Complaint, with the intent that others rely thereon in connection with Glock’s manufacture, marketing, and sale of firearms.

251. Such acts, practices, and omissions by Glock include, but are not limited to the following: (i) advertising fully automatic handguns as desirable and “fun,” and (ii) promoting

¹¹³ “[U]nfair or unconscionable practice” was added to Minnesota Statutes section 325F.69, subdivision 1 and took effect on August 1, 2023. 2023 Minn. Laws ch. 57, art. 4 § 16.

Glock handguns as particularly easy to customize by accessing internal parts and systems and attaching accessories based on Glock's "simple" and "easy" design, without disclosing that it is illegal under Minnesota law for civilians to purchase, possess, or use fully automatic weapons and without disclosing that it is illegal for anyone to equip a Glock handgun with a switch. As the manufacturer of Glock handguns, Glock had special knowledge about its handgun products and their ease of conversion, yet failed to prevent Glock's advertising representations from being misleading.

252. Glock's conduct, practices, actions, and material omissions were also unfair and unconscionable under each of the three tenets of unfairness and unconscionability provided in Minn. Stat. § 325F.69, subd. 8.

253. First, Glock's design, manufacture, and sale of handguns that are easily converted into illegal and highly dangerous machine guns offends public policy established by Minnesota law prohibiting machine guns, including Minn. Stat. § 609.67, because Glock—through its actions and inactions—has, and continues to, knowingly facilitate, permit, and acquiesce to having Glock semi-automatic handguns converted into illegal, fully automatic machine guns.

254. Second, Glock's design, manufacture, and sale of handguns that are easily converted into illegal and highly dangerous machine guns is also unethical, oppressive, and unscrupulous, particularly given how Glock markets its fully automatic weapons to potential handgun buyers as attractive, desirable, and "fun," when they are illegal to purchase or possess by civilian consumers.

255. Finally, Glock's design, manufacture, and sale of semi-automatic handguns that are easily converted into illegal and highly dangerous machine guns is also substantially injurious to

Minnesotans because Glock handguns equipped with switches are dangerous to use and injure and kill people.

256. Glock knows that the design of its semi-automatic handguns makes it easy to convert them into illegal machine guns. Glock intends for consumers to rely on this design and Glock's marketing representations when making purchasing decisions.

257. There is a causal nexus between Glock's conduct, practices, actions, and material omissions described in this Complaint and the harms suffered by Minnesotans.

258. Glock's conduct, practices, actions, and material omissions described in this Complaint constitute multiple violations of the CFA.

COUNT IV
Deceptive Trade Practices Act
Minnesota Statutes Section 325D.44
(All Defendants)

259. The State re-alleges all prior paragraphs of this Complaint.

260. The Minnesota Uniform Deceptive Trade Practices Act ("DTPA") provides, in part:

A person engages in a deceptive trade practice when, in the course of business, vocation, or occupation, the person:

(5) represents that goods or services have sponsorship, approval, characteristics, ingredients, uses, benefits, or quantities that they do not have or that a person has a sponsorship, approval, status, affiliation, or connection that the person does not have;

(7) represents that goods or services are of a particular standard, quality, or grade, or that goods are of a particular style or model, if they are of another;

- (13) engages in (i) unfair methods of competition, or (ii) unfair or unconscionable acts or practices; or
- (14) engages in any other conduct which similarly creates a likelihood of confusion or of misunderstanding.

Minn. Stat. § 325D.44, subd. 1.¹¹⁴

261. For purposes of clause (13) above, “the standard of proof provided under section 325F.69, subdivision 8, applies.” Minn. Stat. § 325D.44, subd. 2(b).

262. An “unfair or unconscionable act or practice” is further defined by Minnesota Statute section 325F.69, subd. 8, as “any method of competition, act, or practice that: (1) offends public policy as established by the statutes, rules, or common law of Minnesota; (2) is unethical, oppressive, or unscrupulous; or (3) is substantially injurious to consumers.”

263. Both Glock defendants are “person[s]” within the meaning of this statute.

264. In the course of its business, vocation, and occupation, Glock repeatedly violated the DTPA by engaging in the deceptive, unfair, and unconscionable trade practices and omissions described in this Complaint in connection with Glock’s manufacture, marketing, and sale of firearms.

265. Such deceptive, unfair, and unconscionable trade practices and omissions by Glock include, but are not limited to the following: (i) advertising fully automatic handguns as desirable and “fun,” and (ii) promoting Glock handguns as particularly easy to customize by accessing internal parts and systems and attaching accessories based on Glock’s “simple” and “easy” design, without disclosing that it is illegal under Minnesota law for civilians to purchase, possess, or use

¹¹⁴ Clause (13), prohibiting “unfair methods of competition” and “unfair or unconscionable acts or practices” was added to Minnesota Statutes section 325D.44, subdivision 1, and took effect on August 1, 2023. 2023 Minn. Laws ch. 57, art. 4 § 6.

fully automatic weapons and without disclosing that it is illegal for anyone to equip a Glock handgun with a switch. As the manufacturer of Glock handguns, Glock had special knowledge about its handgun products and their ease of conversion, yet failed to say enough to prevent its advertising representations from being misleading.

266. Glock's conduct, practices, actions, and material omissions were also unfair and unconscionable under each of the three tenets of unfairness and unconscionability provided in Minn. Stat. § 325F.69, subd. 8.

267. First, Glock's design, manufacture, and sale of handguns that are easily converted into illegal and highly dangerous machine guns offends public policy established by Minnesota law prohibiting machine guns, including Minn. Stat. § 609.67, because Glock—through its actions and inactions—has, and continues to, knowingly facilitate, permit, and acquiesce to having Glock semi-automatic handguns converted into illegal, fully automatic machine guns.

268. Second, Glock's design, manufacture, and sale of handguns that are easily converted into illegal and highly dangerous machine guns is also unethical, oppressive, and unscrupulous, particularly given how Glock markets Glock's fully automatic weapons to potential handgun buyers as attractive, desirable, and "fun," when they are illegal to purchase or possess by civilian consumers.

269. Finally, Glock's design, manufacture, and sale of semi-automatic handguns that are easily converted into illegal and highly dangerous machine guns is also substantially injurious to Minnesotans because Glock handguns equipped with switches are dangerous to use and injure and kill people.

270. There is a causal nexus between Glock's conduct, practices, actions, and material omissions described in this Complaint and the harms suffered by Minnesotans.

271. Glock's conduct, practices, actions, and material omissions described in this Complaint constitute multiple violations of the DTPA.

COUNT V
False Statement in Advertisement, Minnesota Statutes Section 325F.67
(All Defendants)

272. The State re-alleges all prior paragraphs of this Complaint.

273. The False Statement in Advertisement Act ("FSAA") provides, in part:

Any person, firm, corporation, or association who, with intent to sell or in anywise dispose of merchandise. . . for sale or distribution . . . makes, publishes, disseminates, circulates, or places before the public, or causes, directly or indirectly, to be made, published, disseminated, circulated, or placed before the public, in this state . . . an advertisement of any sort regarding merchandise. . . which advertisement contains any material assertion, representation, or statement of fact which is untrue, deceptive, or misleading, shall, whether or not pecuniary or other specific damage to any person occurs as a direct result thereof, be guilty of a misdemeanor, and any such act is declared to be a public nuisance and may be enjoined as such.

Minn. Stat. § 325F.67.

274. Glock's semi-automatic and fully automatic handguns are "merchandise" within the meaning of this statute.

275. Both Defendants are "person[s]" and "corporation[s]," within the meaning of this statute.

276. Glock's conduct, practices, actions, and material omissions repeatedly violated Minnesota Statutes section 325F.67 by making, publishing, disseminating, circulating, and placing before the public advertisements that contained material assertions, representations, omissions, and statements of fact that were untrue, deceptive, or misleading, including but not limited to the following: (i) advertising fully automatic handguns as desirable and "fun," and (ii) promoting Glock handguns as particularly easy to customize by accessing internal mechanics or attaching accessories based on Glock's "simple" and "easy" design, without disclosing that it is illegal under

Minnesota law for civilians to purchase, possess, or use fully automatic weapons and that it is illegal for anyone to equip a Glock handgun with a Glock switch. As the manufacturer of Glock handguns, Glock had special knowledge about its products and their ease of conversion, yet failed to say enough to prevent its advertising representations from being misleading.

277. There is a causal nexus between Glock's conduct, practices, actions, and material omissions described in this Complaint and the harms suffered by Minnesotans.

278. Glock's conduct, practices, actions, and material omissions described in this Complaint constitute multiple violations of the FSAA.

COUNT VI
Negligence
(All Defendants)

279. The State re-alleges all prior paragraphs of this Complaint.

280. Glock has a duty of reasonable care because Glock designs, manufactures, and sells uniquely dangerous products—semi-automatic handguns that can easily be converted into illegal machine guns—and because Glock's conduct created and creates a foreseeable risk of injury to foreseeable people in Minnesota.

281. Glock failed to exercise reasonable care and breached its duty by designing Glock semi-automatic handguns such that they can be easily converted into illegal machine guns and refusing to update or alter its designs to prevent the easy conversion of Glock semi-automatic handguns into illegal machine guns.

282. Through the conduct described herein, Glock has breached and continues to breach its duty of care to the State and its citizens.

283. Glock further breached its duty by engaging in conduct that knowingly violated, and aided and abetted the violation of, Minnesota law, including Minnesota Statutes sections 325D.44, 325F.67, 325F.69, 609.67, and 609.74.

284. As a direct and proximate result of Glock's negligent conduct described herein, the State and its residents have been injured, including by death, injury, lack of safety, and monetary loss, and will continue to suffer substantial harm.

285. Glock's breach of duty is the proximate cause of such injuries because they were foreseeable and Glock's conduct was a substantial factor in bringing about these injuries.

286. Glock's conduct, practices, and actions described in this Complaint constitute multiple instances of negligence under Minnesota law.

COUNT VII
Products Liability
(All Defendants)

287. The State re-alleges all prior paragraphs of this Complaint.

288. Glock is engaged in the business of designing, manufacturing, and selling handguns to Minnesotans.

289. As manufacturers of a dangerous instrumentality, Glock has a duty to use reasonable care to design handguns that are not unreasonably dangerous to those exposed to the product when the product is used as intended or in a way that Glock could reasonably have anticipated.

290. Glock has a further duty to keep up with scientific knowledge and advances in the field of gunsmithing and firearm design.

291. Glock breached these duties by unreasonably designing and manufacturing Glock handguns in such a way to facilitate their straightforward and easy modification by Glock switches

into fully automatic machine guns that are unreasonably dangerous to those potentially exposed to the handguns, including members of the public that are put at risk by the uncontrollable nature of fully automatic weapon fire.

292. Glock further breached these duties by knowing about the use of Glock switches with Glock handguns and yet unreasonably refusing to modify the design of Glock handguns to prevent the substantial and foreseeable likely harm posed by Glock's handguns equipped with Glock switches.

293. Glock also breached these duties by failing to warn about the dangers and illegality of converting Glock semi-automatic handguns with Glock switches, thereby making Glock semi-automatic handguns unreasonably dangerous to their users and the public at large.

294. Because of Glock's design, manufacture, and sale decisions, Glock handguns pose a substantial, foreseeable, and likely harm to the public, above and beyond that of typical semi-automatic firearms.

295. This harm is not theoretical—as shown herein, Glock handguns equipped with Glock switches have caused significant harm in Minnesota, and throughout the country.

296. There are feasible changes Glock could make to the design and manufacture of its handguns to prevent the use of Glock switches—including as Glock has done with respect to the back plate on the G46—but Glock has refused to make such changes.

297. Because Glock has not improved the manufacture and design of its semi-automatic handguns sold in the United States, beyond adding an easily defeatable plastic tab to newer models, it would seem that Glock has not implemented scientific knowledge and advances in the fields of gunsmithing and firearm design that could inhibit the use of Glock switches to modify Glock handguns into fully automatic machine guns.

298. This design defect is not caused by voluntary, abnormal, or unusual handling of Glock handguns by owners; rather, this design defect is present from the initial point of design and manufacture by Glock all the way through to when guns are sold at retail to customers.

299. Glock is vicariously liable for the actions or inactions of Glock's agents and/or employees while in the scope of their agency and/or employment.

300. As a direct and proximate result of Glock's negligent conduct described herein, the State and its residents have been injured, including by death, injury, lack of safety, and monetary loss, and will continue to suffer substantial harm.

301. Glock's breach of duty is the proximate cause of such injuries because they were foreseeable and Glock's conduct was a substantial factor in bringing about these injuries.

302. Glock's conduct, practices, and actions described in this Complaint constitute multiple instances of negligent design under Minnesota law.

RELIEF

WHEREFORE, the State of Minnesota, by its Attorney General, Keith Ellison, respectfully asks this Court to award judgment against Defendants Glock, Inc. and Glock Ges.m.b.H., jointly and severally, as follows:

1. Declaring that Glock's conduct described in this Complaint constitutes a public nuisance, and permanently enjoining Glock from continuing in the acts, practices, and conduct that created and maintained the nuisance;

2. Declaring that Glock's conduct constitutes multiple, separate violations of the Prevention of Consumer Fraud Act (Minn. Stat. § 325F.69), the Uniform Deceptive Trade Practices Act (Minn. Stat. § 325D.44), and the False Statement in Advertisement Act (Minn. Stat. § 325F.67);

3. Enjoining Defendants and their employees, officers, directors, agents, servants, successors, assignees, affiliates, merged or acquired predecessors, parent or controlling entities, subsidiaries, and all other persons acting in concert or participation with them from engaging in conduct in violation of Minn. Stat. §§ 325D.44, 325F.69, 325F.67, and 609.74;

4. Ordering Defendants to modify the design of Defendants' semi-automatic handguns that are sold to the public and can be converted with a Glock switch, including the Glock 17 and Glock 19, so that these handguns cannot be easily converted into fully automatic machine guns;

5. Awarding judgment against Defendants for maximum civil penalties pursuant to Minnesota Statutes section 8.31, subdivision 3, for each separate violation of Minnesota law;

6. Ordering Defendants to abate the public nuisance they have created and/or maintained, including by ordering judgment against Defendants in an amount necessary to abate the public nuisance;

7. Awarding judgment against Defendants for restitution and disgorgement under the *parens patriae* doctrine, the equitable powers of the Court, Minnesota Statutes section 8.31, and any other authority;

8. Awarding judgment against Defendants for monetary relief pursuant to Minnesota law, the *parens patriae* doctrine, Minnesota Statutes section 8.31, and the equitable powers of the Court, as necessary to remedy harms to Minnesotans resulting from Defendants' unlawful conduct;

9. Awarding the State its costs, including costs of investigation and attorney fees, as authorized by Minnesota Statutes sections 8.31, subdivision 3a; and

10. Granting such further relief as provided by law or equity as the Court deems appropriate and just.

JURY DEMAND

The State demands a jury trial for all issues pled herein triable by a jury.

Dated: December 12, 2024

KEITH ELLISON
Attorney General
State of Minnesota

JAMES W. CANADAY (#030234X)
Deputy Attorney General

/s/ Katherine Moerke

KATHERINE MOERKE (#0312277)
JASON PLEGGENKUHLE (#0391772)
ERIC J. MALONEY (#0396326)
JACOB HARRIS (#0399255)
JON M. WOODRUFF (#399453)
SARAH DOKTORI (#0403060)
Assistant Attorneys General

445 Minnesota Street, Suite 1200
St. Paul, Minnesota 55101-2130
james.canaday@ag.state.mn.us
Telephone: (651) 757-1421
katherine.moerke@ag.state.mn.us
Telephone: (651) 757-1288
jason.pleggenkuhle@ag.state.mn.us
Telephone: (651) 757-1147
eric.maloney@ag.state.mn.us
Telephone: (651) 757-1021
jacob.harris@ag.state.mn.us
Telephone: (651) 857-1156
jon.woodruff@ag.state.mn.us
Telephone: (651) 300-7425
sarah.doktori@ag.state.mn.us
Telephone: (651) 757-1029

GIFFORDS LAW CENTER TO PREVENT GUN VIOLENCE

DAVID PUCINO (*pro hac vice* motion
forthcoming)
WILLIAM T. CLARK (*pro hac vice* motion
forthcoming)
LEKHA MENON (*pro hac vice* motion
forthcoming)

244 Madison Avenue, Ste 147
New York, NY 10016
Telephone: (415) 433-2062
dpucino@giffords.org
wclark@giffords.org
lmenon@giffords.org

ESTHER SANCHEZ-GOMEZ (*pro hac vice*
motion forthcoming)
268 Bush Street, #555
San Francisco, CA 94104
Telephone: (415) 433-3357
esanchezgomez@giffords.org

KELLY M. PERCIVAL (*pro hac vice* motion
forthcoming)
P.O. Box 51196
Washington, DC 20091
Telephone: (415) 433-2062
kpercival@giffords.org

**UNIVERSITY OF MINNESOTA GUN
VIOLENCE PREVENTION CLINIC**

MEGAN WALSH (#0394837)
MARIA AQUINO-DORAN (#0395054)
Special Assistant Attorneys General

EMILY BYERS OLSON
ROSE LEWIS
MELISSA HARTLEY
Certified Student Attorneys

University of Minnesota Law School
190 Mondale Hall
229 19th Avenue South
Minneapolis, MN 55455
Phone: (612) 625-5515
wals0270@umn.edu
aquin061@umn.edu
hartl303@umn.edu
byers064@umn.edu
lewi780@umn.edu

Attorneys for State of Minnesota

MINN. STAT. § 549.211 ACKNOWLEDGMENT

The party on whose behalf the attached document is served acknowledges through its undersigned counsel that sanctions, including reasonable attorney fees and other expenses, may be awarded to the opposite party or parties pursuant to Minn. Stat. § 549.211.

/s/ Katherine Moerke

KATHERINE MOERKE
Assistant Attorney General